



**BOARD OF ADJUSTMENT MEETING NOTICE:**

February 17, 2021

A Public Hearing will be held before the Board of Adjustment on Wednesday, **March 10, 2021 at 6:30 P.M.**

This meeting will be held in-person and virtually to determine whether the following application should be granted. To view more information about this item, please visit: [www.fortlauderdale.gov/government/BOA](http://www.fortlauderdale.gov/government/BOA).

<b>CASE:</b>	<b>PLN-BOA-21020001</b>
<b>OWNER:</b>	2426 EAST LAS OLAS LLC
<b>AGENT:</b>	OLIVE JUDD, PA, KRISTY E. ARMADA
<b>ADDRESS:</b>	2426 E LAS OLAS BOULEVARD, FORT LAUDERDALE FL 33301
<b>LEGAL DESCRIPTION:</b>	RESUB BLKS 13 & 14 IDLEWYLD 7-38 B LOT 1 LESS E 50 & E 30 OF LOT 2 BLK 13
<b>ZONING:</b>	CB
<b>COMMISSION DISTRICT:</b>	2
<b>REQUESTING:</b>	<b><u>Sec. 47-6.20. - Table of dimensional requirements. (Note A)</u></b>

Requesting a variance from the 5 feet minimum front yard requirements of Sec. 47-6.20 Table of Dimensional Requirements (Note A) for the CB zoning district to permit a new store front wall at a setback distance of 2 feet 3 inches, a total variance request of 2 feet 9 inches.

**To Attend In-Person:**

City of Fort Lauderdale, City Hall Commission Chambers, 100 N. Andrews Avenue, Fort Lauderdale, FL 33301

**To Attend Virtually:**

Visit: [www.fortlauderdale.gov/FLTV](http://www.fortlauderdale.gov/FLTV) to watch and listen to the meeting

Visit: <https://www.fortlauderdale.gov/government/BOA> to sign up to speak. Should you desire to speak on this item, please fill out the speaker form available at the link on the City's website.

If you have any questions, please feel free to contact me directly at 954-828-6342.

**MOHAMMED MALIK  
ZONING ADMINISTRATOR**

Florida Statutes, Sec. 286.0105

NOTE: If any person decides to appeal any decision made with respect to any matter considered at this public meeting or hearing, he/she will need a record of the proceedings, and for such purpose, he/she may need to ensure that a verbatim record of the proceeding is made, which record includes the testimony and evidence upon which the appeal is to be based.



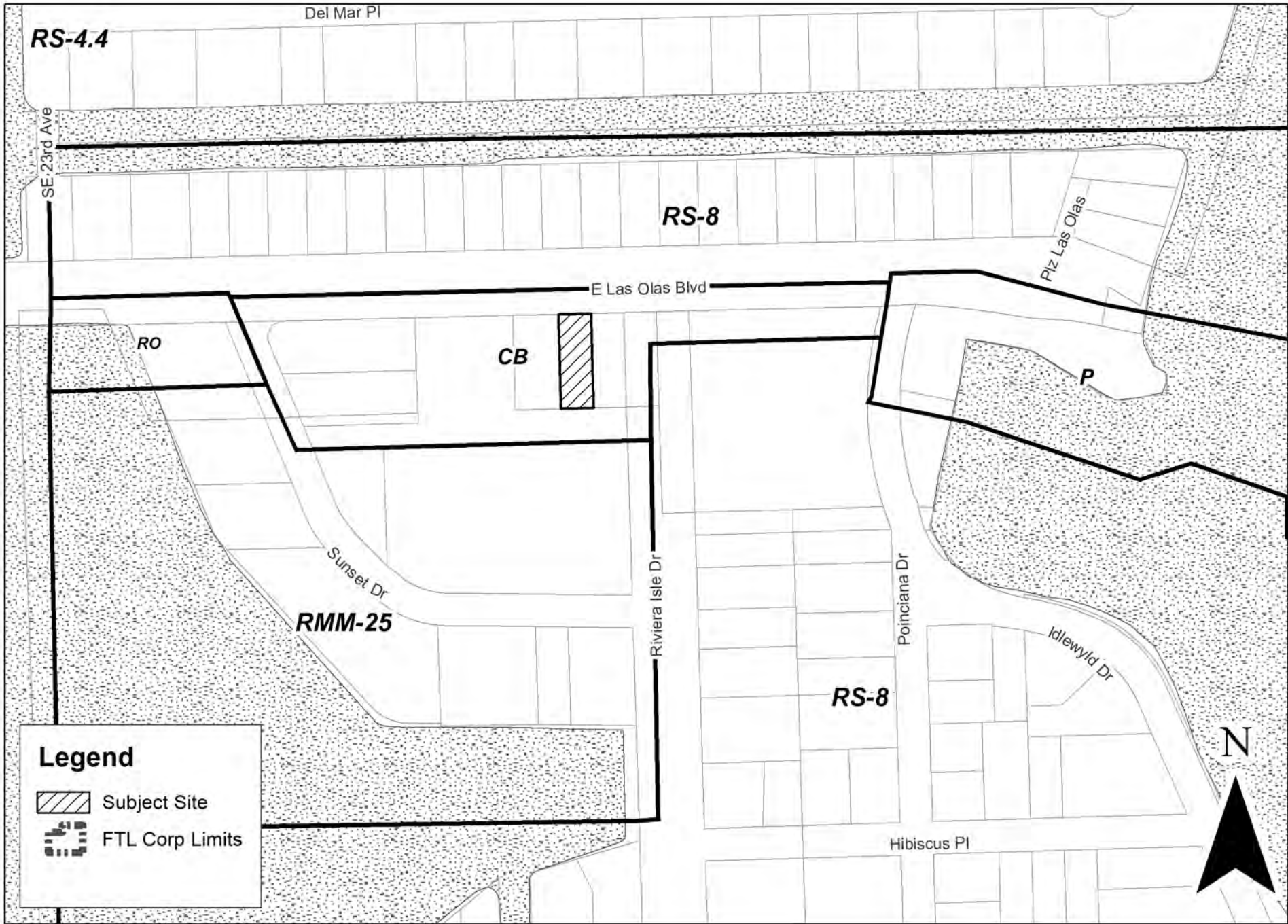

**Legend**

-  Subject Site
-  FTL Corp Limits

**PLN-BOA-21020001**

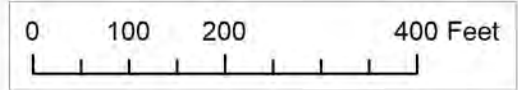

Graphic Scale



CITY OF FORT LAUDERDALE  
**PUBLIC NOTICE**

# BOARD OF ADJUSTMENTS MEETING

DATE: MARCH 10, 2021

TIME: 6:30 PM

CASE: PLN-BOA-21020001

Requesting: Sec. 47-6.20. - Table of dimensional requirements. (Note A)

Requesting a variance from the 5 feet minimum front yard requirements of Sec. 47-6.20 Table of Dimensional Requirements (Note A) for the CB zoning district to permit a new store front wall at a setback distance of 2 feet 3 inches, a total variance request of 2 feet 9 inches.

LOCATION: CITY COMMISSION CHAMBERS  
CITY HALL, 100 N ANDREWS AVENUE

CONTACT: 954-828-6506

You Can Still Attend The Meeting Virtually:

Visit [www.fortlauderdale.gov/fltv](http://www.fortlauderdale.gov/fltv) to watch and listen to the meeting.

Visit <https://www.fortlauderdale.gov/government/BOA> to sign up to speak.

*This Notice is the property of the City of Fort Lauderdale. In accordance with City Code Section 16-29, It shall be unlawful for any person to injure, cut, break or destroy in any manner any building or other thing belonging to or under the control of the City. Persons marring or removing the Notice may be subject to fine and/or imprisonment.*

*In accordance with City Code Section 47-27.2A. H The sign shall remain on the property until final disposition of the application. This shall include any deferral, rehearing, appeal, request for review or hearing by another body. The sign information shall be changed as provided in subsection A.3.a*



Record #	Description Application Name	Record Type	Balance	Planner	Street #	Dir	Street Name	Type	Opened Date	Status
PLN-BOA-21020001	2426 East Las Olas Blvd Renovation	Z- Board of Adjustment (BOA)	0		2426	E	LAS OLAS	BLVD	2/4/2021	Awaiting Client Reply
BLD-CALT-20110005	CONFERENCE ROOM EXPANSION	Commercial Alteration Permit	934.59		2426	E	LAS OLAS	BLVD	11/4/2020	In Process
ELE-COM-20110009	ELECTRICAL WORK FOR CONFERENCE ROOM EXPANSION	Electrical Commercial Permit	111		2426	E	LAS OLAS	BLVD	11/4/2020	In Process
MEC-COM-20110007	HVAC WORK FOR CONFERENCE ROOM EXPANSION	Mechanical Commercial Permit	105		2426	E	LAS OLAS	BLVD	11/4/2020	Awaiting Client Reply
BT-SLP-REN-20070109	State Licensed Professional Renewal	Professional Business Tax Renewal (State,County,Federal,Registered, etc.)	0		2426	E	LAS OLAS	BLVD	7/1/2020	Complete
BT-SLP-REN-20070188	State Licensed Professional Renewal	Professional Business Tax Renewal (State,County,Federal,Registered, etc.)	0		2426	E	LAS OLAS	BLVD	7/1/2020	Closed
BT-SLP-REN-20070754	State Licensed Professional Renewal	Professional Business Tax Renewal (State,County,Federal,Registered, etc.)	0		2426	E	LAS OLAS	BLVD	7/1/2020	Complete
BT-SLP-REN-20070876	State Licensed Professional Renewal	Professional Business Tax Renewal (State,County,Federal,Registered, etc.)	0		2426	E	LAS OLAS	BLVD	7/1/2020	Complete
BT-SLP-REN-20070877	State Licensed Professional Renewal	Professional Business Tax Renewal (State,County,Federal,Registered, etc.)	0		2426	E	LAS OLAS	BLVD	7/1/2020	Complete
BT-SLP-REN-20071590	State Licensed Professional Renewal	Professional Business Tax Renewal (State,County,Federal,Registered, etc.)	0		2426	E	LAS OLAS	BLVD	7/1/2020	Complete
BT-SLP-REN-20071961	State Licensed Professional Renewal	Professional Business Tax Renewal (State,County,Federal,Registered, etc.)	0		2426	E	LAS OLAS	BLVD	7/1/2020	Complete
BT-SLP-REN-20071962	State Licensed Professional Renewal	Professional Business Tax Renewal (State,County,Federal,Registered, etc.)	0		2426	E	LAS OLAS	BLVD	7/1/2020	Closed
BT-SLP-REN-20071963	State Licensed Professional Renewal	Professional Business Tax Renewal (State,County,Federal,Registered, etc.)	0		2426	E	LAS OLAS	BLVD	7/1/2020	Closed
BT-SLP-REN-20071964	State Licensed Professional Renewal	Professional Business Tax Renewal (State,County,Federal,Registered, etc.)	0		2426	E	LAS OLAS	BLVD	7/1/2020	Complete
BT-SLP-REN-20073462	State Licensed Professional Renewal	Professional Business Tax Renewal (State,County,Federal,Registered, etc.)	446.89		2426	E	LAS OLAS	BLVD	7/1/2020	In Process
BT-SLP-REN-20073463	State Licensed Professional Renewal	Professional Business Tax Renewal (State,County,Federal,Registered, etc.)	0		2426	E	LAS OLAS	BLVD	7/1/2020	Closed
BT-GEN-REN-20073449	General Renewal	General Business Tax Renewal	0		2426	E	LAS OLAS	BLVD	7/1/2020	Complete
BT-SLP-REN-20075565	State Licensed Professional Renewal	Professional Business Tax Renewal (State,County,Federal,Registered, etc.)	0		2426	E	LAS OLAS	BLVD	7/1/2020	Closed
BT-SLP-REN-20075791	State Licensed Professional Renewal	Professional Business Tax Renewal (State,County,Federal,Registered, etc.)	0		2426	E	LAS OLAS	BLVD	7/1/2020	Complete
BL-1702544	KATZMAN,JASON	Professional Business Tax Receipt (State,County,Federal,Registered, etc.)	0		2426	E	LAS OLAS	BLVD	7/9/2018	Delinquent
BL-1702545	HACKLEMAN OLIVE & JUDD PA	General Business Tax Receipt	0		2426	E	LAS OLAS	BLVD	7/9/2018	Active
BL-1702546	DAUGHERTY,MARGARET A	Professional Business Tax Receipt (State,County,Federal,Registered, etc.)	0		2426	E	LAS OLAS	BLVD	7/9/2018	Closed
CE16120553	ILLEGAL RE 2426 EAST LAS OLAS LLC	Code Case	0		2426	E	LAS OLAS	BLVD	12/8/2016	Closed
VIO-CE16120553_1	2426 EAST LAS OLAS LLC	Violation-CODE Hearing	0		2426	E	LAS OLAS	BLVD	12/8/2016	Closed
CE16061359	NON-PERN 2426 EAST LAS OLAS LLC	Code Case	0		2426	E	LAS OLAS	BLVD	6/16/2016	Closed
PM-15111452	3 INTERIOR 3 INTERIOR HURRICANE SHUTTERS	Shutter Permit	173.83		2426	E	LAS OLAS	BLVD	11/18/2015	In Process
BL-1402056	MANCA,ALBERTO	Professional Business Tax Receipt (State,County,Federal,Registered, etc.)	0		2426	E	LAS OLAS	BLVD	7/23/2015	Closed
PM-15060936	BACKFLOW BACKFLOW RECERT .75INCH RP	Plumbing Backflow Installation Permit	0		2426	E	LAS OLAS	BLVD	6/9/2015	Complete
BL-1302374	SANCHEZ,MATTHEW	Professional Business Tax Receipt (State,County,Federal,Registered, etc.)	0		2426	E	LAS OLAS	BLVD	9/19/2014	Active
BL-1302375	SHARPE,JENNIFER	Professional Business Tax Receipt (State,County,Federal,Registered, etc.)	196.88		2426	E	LAS OLAS	BLVD	9/19/2014	Closed
BL-1302377	STROCHLIC,KARA	Professional Business Tax Receipt (State,County,Federal,Registered, etc.)	0		2426	E	LAS OLAS	BLVD	9/19/2014	Closed
BL-1302378	VILLARROEL,NICOLE	Professional Business Tax Receipt (State,County,Federal,Registered, etc.)	0		2426	E	LAS OLAS	BLVD	9/19/2014	Active
CE14090619	BUILDING 2426 EAST LAS OLAS LLC	Building Code Case	0		2426	E	LAS OLAS	BLVD	9/9/2014	Closed
VIO-CE14090619_1	BUILDING 2426 EAST LAS OLAS LLC	Violation-BLD Hearing	0		2426	E	LAS OLAS	BLVD	9/9/2014	Closed
PM-14061160	RECERTIFI (RECERTIFICATION BACKFLOW	Plumbing Backflow Installation Permit	1.29		2426	E	LAS OLAS	BLVD	6/13/2014	Void
PM-14041494	CHANNEL CHANNEL LETTERS WALL FLAT ELEC	Sign Permit	0		2426	E	LAS OLAS	BLVD	4/18/2014	Complete
PM-14041496	ELECTRIC F ELECTRIC FOR SIGN	Sign Permit	0		2426	E	LAS OLAS	BLVD	4/18/2014	Complete
PM-14040404	30 DAY TEI 30 DAY TEMP FOR TEST	Electrical 30 Day Temp For Test	0		2426	E	LAS OLAS	BLVD	4/4/2014	Complete
PM-14010544	35 LN OF F 35 LN OF FENCE CHAIN LINK 4'H	Fence Permit	0		2426	E	LAS OLAS	BLVD	1/10/2014	Complete



	NEW A/C INSTALLA TION FOR INTERIOR RENOVAT ION BP ~1310196							
PM-13101968	5 NEW A/C INSTALLATION FOR INTERIOR RENOVATION BP	Mechanical HVAC New Install Permit	0	2426 E	LAS OLAS	BLVD	10/25/2013	Complete
PM-13100178	#A & #A & B INTERIOR DEMO	Commercial Demolition Permit	0	2426 E	LAS OLAS	BLVD	10/2/2013	Complete
PM-13100181	#A & #A & B ELECTRIC FOR INT DEMO BP13100178	Electrical Commercial Permit	0	2426 E	LAS OLAS	BLVD	10/2/2013	Complete
PM-13100182	# A & # A & B PLUMBING FOR INT DEMO BP13100178	Plumbing Commercial Permit	0	2426 E	LAS OLAS	BLVD	10/2/2013	Complete
PL-1242L13	ZVL - NICOLE M. CAUZ	Z- Zoning Verification Letter	0	2426 E	LAS OLAS	BLVD	8/22/2013	Closed
PL-1232L13	ZVL - NICOLE M CAUZ - HACKLEMAN, OLIVE & JUDD P.A.	Z- Zoning Verification Letter	0	2426 E	LAS OLAS	BLVD	8/16/2013	Closed
BL-1201752	MY PERFECT WINE & SPIRITS	Retail - Wholesale Business Tax Receipt	0	2426 E	LAS OLAS	BLVD	3/15/2013	Closed
BL-1302380	GAUKROGER,ELIZABETH	Professional Business Tax Receipt (State,County,Federal,Registered, etc.)	0	2426 E	LAS OLAS	BLVD	12/14/2012	Closed
BL-1501042	HOFFMAN,STEPHEN	Professional Business Tax Receipt (State,County,Federal,Registered, etc.)	0	2426 E	LAS OLAS	BLVD	6/8/2012	Active
PM-11051201	RECERTIFY RECERTIFY 3/4 INCH RP BACKFLOW 7009 0080 0000 1173 0657 ~ ~ ~7007 3020 0001 3549	Plumbing Backflow Installation Permit	0	2426 E	LAS OLAS	BLVD	5/17/2011	Complete
PM-09051022	1701 7009 0080 0000 1173 0657	Building Recertification	0	2426 E	LAS OLAS	BLVD	5/13/2009	Complete
BL-1302383	OLIVE,BENJAMIN ERIC	Professional Business Tax Receipt (State,County,Federal,Registered, etc.)	0	2426 E	LAS OLAS	BLVD	8/12/2008	Active
BL-1302384	ARMADA,KRISTY ELIZABETH	Professional Business Tax Receipt (State,County,Federal,Registered, etc.)	0	2426 E	LAS OLAS	BLVD	8/7/2008	Active
BL-1302373	OLIVE,MARISA	Professional Business Tax Receipt (State,County,Federal,Registered, etc.)	0	2426 E	LAS OLAS	BLVD	11/29/2007	Active
PM-05040663	SERVICE C SERVICE CHANGE	Electrical Services Permit	0	2426 E	LAS OLAS	BLVD	4/7/2005	Complete
PM-04060637	REPL WAT REPL WATER SERVICE	Plumbing Meter Install Permit	0	2426 E	LAS OLAS	BLVD	6/7/2004	Complete
PM-04030789	ANDREA'S ANDREA'S LINENS-REPL ONE 7.5 TON SPLIT AC UNIT	Mechanical HVAC Changeout Permit	0	2426 E	LAS OLAS	BLVD	3/9/2004	Complete
BL-1302379	BARDUNIAS,HELAINA	Professional Business Tax Receipt (State,County,Federal,Registered, etc.)	0	2426 E	LAS OLAS	BLVD	7/29/2002	Closed
PM-01110031	RAISE (1) C RAISE (1) ONE PKG UNIT PUT ON STAND FOR REROOF	Mechanical Commercial Permit	0	2426 E	LAS OLAS	BLVD	11/1/2001	Complete
PM-01101086	RELOCATE RELOCATE CONDUITS FOR ROOF REPAIR BP 01100646	Electrical Commercial Permit	0	2426 E	LAS OLAS	BLVD	10/16/2001	Complete
PM-01100646	REROOF-7: REROOF-7240SF-FLAT FOR COMMERCIAL BLDG	Re-Roof Permit	0	2426 E	LAS OLAS	BLVD	10/9/2001	Complete
BL-1302376	PETERSEN CHRISTIAN A	Professional Business Tax Receipt (State,County,Federal,Registered, etc.)	0	2426 E	LAS OLAS	BLVD	5/14/2001	Active
PM-00060775	RAISE A/C RAISE A/C UNITS (2)/ARLENS LINENS & THINGS	Mechanical Commercial Permit	0	2426 E	LAS OLAS	BLVD	6/8/2000	Complete
PM-00051527	COMMERC COMMERCIAL FLAT 5200SF	Re-Roof Permit	0	2426 E	LAS OLAS	BLVD	5/19/2000	Complete
FS-23070196	2426 EAST LAS OLAS LLC	Fire Safety Account	0	2426 E	LAS OLAS	BLVD	11/25/1996	Active
BL-645317	ANDREA'S LAS OLAS LINENS INC.	Retail - Wholesale Business Tax Receipt	0	2426 E	LAS OLAS	BLVD	9/28/1994	Closed
BL-1302382	JUDD ROBERT B	Professional Business Tax Receipt (State,County,Federal,Registered, etc.)	0	2426 E	LAS OLAS	BLVD	11/4/1985	Active
BL-1302381	HACKLEMAN ROBERT S	Professional Business Tax Receipt (State,County,Federal,Registered, etc.)	0	2426 E	LAS OLAS	BLVD	9/1/1980	Closed

CASE: PLN-BOA-21020001

Sec. 47-6.20. - Table of dimensional requirements. (Note A)

<b>Requirements</b>	<b>District</b>			
	<b>CB</b>	<b>B-1</b>	<b>B-2</b>	<b>B-3</b>
<b>Maximum height (ft.)</b> <i>Note B</i>	150	150	150	150
<b>Minimum lot size</b> Minimum lot width	None	None	None	None
<b>Maximum FAR</b>	None	None	None	None
<b>Minimum front yard (ft.)</b>	5*	5*	5*	5*
<b>Minimum corner yard (ft.)</b>	5*	5*	5*	5*
<b>Minimum side yard (ft.):</b>				
When contiguous to residential property	10	10	15	20
All others	None	None	None	None, except when any portion of a structure is greater in height than 100 ft. that portion of the structure shall be set back an additional 1 ft. for each 1 ft. of building height over 100 ft.
<b>Minimum rear yard (ft.):</b>				
When contiguous to residential property	15	15	20	25
All others	None	None	None	None, except when any portion of a structure is greater in height than 100 ft. that portion of the structure shall be set back an additional 1 ft. for each 1 ft. of building height over 100 feet.

Note A: Dimensional regulations may be subject to additional requirements, see Section 47-23, Specific Location Requirements, and Section 47-25, Development Review Criteria.

Note B: East of the Intracoastal Waterway, height for all districts is limited to one hundred twenty (120) feet.

\* Where the height of a building in a business zoning district exceeds nine feet measured from the ground floor elevation, that portion of the building may extend into the front yard area.

(Ord. No. C-97-19, § 1(47-6.4), 6-18-97; Ord. No. C-04-10, § 3, 4-7-04)



# SUSTAINABLE DEVELOPMENT – URBAN DESIGN & PLANNING

## BOARD OF ADJUSTMENT (BOA) APPLICATION

Rev: 2 | Revision Date: 10/2/2020 | Print Date: 10/2/2020  
I.D. Number: Z&L-BOA

### BOARD OF ADJUSTMENT (BOA) Application

- Cover:** Deadline, Notes, and Fees
- Page 1:** Applicant Information Sheet
- Page 2:** Variance Request Criteria
- Page 3:** Required Documentation & Mail Notice Requirements
- Page 4:** Sign Notice Requirements & Affidavit
- Page 5:** Technical Specifications

**DEADLINE:** Submittals must be received prior to 4:00 PM each business day. Pursuant to Section 47-24.12, the Department will review all applications to determine completeness within five (5) business days. Applicants will be notified via e-mail, if plans do not meet the submittal requirements and if changes are required.

**NOTES:** Prior to formal submittal of applications, applicants are encouraged to schedule an appointment with Urban Design & Planning Division staff to obtain feedback regarding proposals. The meetings provide an opportunity for applicants to obtain feedback and general direction, prior to expending significant effort on preparation of submittal documents.

**FEES:** All applications for development permits are established by the City Commission, as set forth by resolution and amended from time to time. In addition to the application fee, any additional costs incurred by the City including review by a consultant on behalf of the City, or special advertising costs shall be paid by the applicant. Any additional costs, which are unknown at the time of application, but are later incurred by the City, shall be paid by the applicant prior to the issuance of a development permit.

- Variance/Special Exception/Interpretation: Before \$2,200
- Variance/Special Exception/Interpretation: After \$2800
- Parking Variance (per space) \$2600
- Variance/Special Exception/Interpretation Before- Residential Homesteaded Only- Accessory Structures & Existing Non-Conforming Structures \$650
- Variance/Special Exception/Interpretation After- Residential Homesteaded Only- Accessory Structures & Existing Non-Conforming Structures \$850
- Request for Continuance \$900
- Rehearing before the Board \$1150
- Request for Rehearing \$300

## Page 1: BOA - Applicant Information Sheet

**INSTRUCTIONS:** The following information is requested pursuant to the City's Unified Land Development Regulations (ULDR). While the information requested in this application is the minimum required to proceed please be aware additional information may be required to fully address the variance requested. The application must be filled out accurately and completely. Please print or type and answer all questions. Indicate N/A if does not apply.

**NOTE:** To be filled out by Department

<b>Case Number</b>	
<b>Date of complete submittal</b>	

**NOTE:** For purpose of identification, the **PROPERTY OWNER** is the **APPLICANT**

<b>Property Owner's Name</b>	2426 EAST LAS OLAS LLC		
<b>Property Owner's Signature</b>	If a signed agent letter is provided, no signature is required on the application by the owner.		
<b>Address, City, State, Zip</b>	2426 East Las Olas Blvd, Fort Lauderdale, FL 33301		
<b>E-mail Address</b>	Bolive@olivejudd.com		
<b>Phone Number</b>	954-334-2250		
<b>Proof of Ownership</b>	<input checked="" type="checkbox"/> <b>Warranty Deed</b> or	<input type="checkbox"/> <b>Tax Record</b>	

**NOTE:** If **AGENT** is to represent **OWNER**, notarized letter of consent is required

<b>Applicant / Agent's Name</b>	Olive Judd, PA, Kristy E. Armada
<b>Applicant / Agent's Signature</b>	
<b>Address, City, State, Zip</b>	2426 East Las Olas Blvd, Fort Lauderdale, FL 33301
<b>E-mail Address</b>	KArmada@olivejudd.com
<b>Phone Number</b>	954-334-2250
<b>Letter of Consent Submitted</b>	Y

<b>Development / Project Name</b>	2426 East Las Olas Blvd Renovation		
<b>Existing / New</b>	<b>Existing:</b> <input type="checkbox"/>	<b>New:</b> <input checked="" type="checkbox"/>	
<b>Project Address</b>	<b>Address:</b> 2426 East Las Olas Blvd, Fort Lauderdale, FL 33301		
<b>Legal Description</b>	RESUB BLKS 13 & 14 IDLEWYLD 7-38 B LOT 1 LESS E 50 & E 30 OF LOT 2 BLK 13		
<b>Tax ID Folio Numbers</b> (For all parcels in development)	5042 12 05 0020		
<b>Request / Description of Project</b>	renovation to existing office, expand conference room, located in the northwest section of the building by moving the northern exterior wall north a distance of 2.25 feet.		
<b>Applicable ULDR Sections</b>	ULDR Sec . 47-6.20		

<b>Current Land Use Designation</b>	Commercial
<b>Current Zoning Designation</b>	CB-Community Business
<b>Current Use of Property</b>	Office
<b>Site Adjacent to Waterway</b>	<input type="checkbox"/> <b>Yes</b> <input checked="" type="checkbox"/> <b>No</b>

Setbacks (indicate direction N,S,E,W)	Required	Proposed
<b>Front</b> <input type="checkbox"/>	5'	2.25'
<b>Side</b> <input type="checkbox"/>	None	
<b>Side</b> <input type="checkbox"/>	None	
<b>Rear</b> <input type="checkbox"/>	None	

## Page 2: Board of Adjustment (BOA) Criteria for Variance Request

This page must be filled in. An attached narrative may be included if additional space is required.

**SPECIFIC REQUEST:** State the specific request according to the ULDR or other provisions of the Code.

Please see attached Narrative

**CRITERIA:** Applicant must demonstrate a unique hardship attributable to the land by proving by a preponderance of the evidence for all of the following criteria. Please answer the following criteria completely. While some criteria may seem duplicative the response should be tailored specifically to each. Per section 47-24.12.A.4,

a. Special conditions and circumstances affect the property at issue which prevent the reasonable use of such property; and

Please see attached Narrative.

b. Circumstances which cause the special conditions are peculiar to the property at issue, or to such a small number of properties that they clearly constitute marked exceptions to other properties in the same zoning district; and:

Please see attached Narrative.

c. Literal application of the provisions of the ULDR would deprive the applicant of a substantial property right that is enjoyed by other property owners in the same zoning district. (It shall be of no importance to this criterion that a denial of the variance sought might deny to the owner a more profitable use of the property, provided the provisions of the ULDR still allow a reasonable use of the property; and

Please see attached Narrative.

d. The unique hardship is not self-created by the applicant or his predecessors, nor is it the result of mere disregard for, or ignorance of, the provisions of the ULDR or antecedent zoning regulations; and

Please see attached Narrative.

e. The variance is the minimum variance that will make possible a reasonable use of the property and that the variance will be in harmony with the general purposes and intent of the ULDR and the use as varied will not be incompatible with adjoining properties or the surrounding neighborhood or otherwise detrimental to the public welfare.

Please see attached Narrative.

**AFFIDAVIT:** I, Benjamin E. Olive the Owner/Agent of said property ATTEST that I am aware of the following:

1. In order to be entitled to the relief requested in the application an affirmative vote of a majority plus one of the Board of Adjustment is required;
2. That in granting the relief requested, the Board of Adjustment is limited to the authority vested in the Board by the ULDR and that the Board may not grant the relief requested unless the applicant proves all the criteria specified in the ULDR have been met;
3. That the granting of relief by the Board does not exempt the applicant or owner of record from the responsibilities of obtaining all applicable permits or approvals as may be required by law for both new and existing structures;
4. That if the relief requested is granted by the Board, the applicant must secure a building permit to implement the relief requested within one hundred eighty (180) days of the entry of the final order of the Board, or within such lesser time as the Board may proscribe and that failure to procure the necessary permits within the time so proscribed shall render the variance or special exception null and void;
5. That if the Board denies the request for relief, then no additional application for the same or substantially the same relief may be entertained by the Board within two (2) years of the date of entry of the final order of denial.

(Signature)

SWORN TO AND SUBSCRIBED before me in the County and State above aforesaid this 4th day of February, 2021

(SEAL)

NOTARY PUBLIC  
MY COMMISSION EXPIRES:

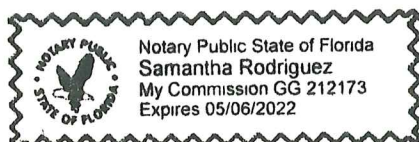

## Page 3: Required Documentation & Mail Notice Requirements

**One (1) original set, signed and sealed, with plans at 24" x 36"**  
**One (1) electronic version (CD or USB) of complete application and plans in PDF format**  
**Fourteen (14) copy sets of each item below and plans at half-size scale 11" x 17"**

- Completed application** (all pages must be filled out where applicable)
- Mail notification documents** (mail notification instructions at bottom of page)
- Proof of ownership** (warranty deed or tax record), including corporation documents if applicable
- Property owners notarized signature** and/or notarized agent letter signed by the property owner (if applicable).
- Color photographs** of the entire property and all surrounding properties, dated and labeled and identified as to orientation.
- Narrative** describing specific request and outlining ULDR sections that are applicable. Narratives must be on letterhead, dated, and with author indicated.
- Cover sheet** on plan set to state project name and table of contents.
- Current survey(s)** of property, signed and sealed, showing existing conditions; survey must be As-Built with Right-of-Way and Easement Vacations Excluded. The survey should consist of the proposed project site alone. Do not include adjacent properties or portions of lands not included in the proposed project unless specifically requested by the City. If the survey is not signed and sealed, a zoning affidavit is required and shall only be used for the structures listed in the affidavit.
- Aerial photo** indicating all properties within 700 ft. of the subject property. Must be clear and current with site highlighted.
- Site Plan (a survey may be substituted if the requested variance is clearly indicated)**
- Landscape Plan (if applicable)**
- Elevations (if applicable)**
- Additional plan details as needed**

**Note:** All copy sets must be clear and legible.

**Note:** Plans must be folded to 8 ½" x 11". All non-plan documents should be 8 ½" x 11".

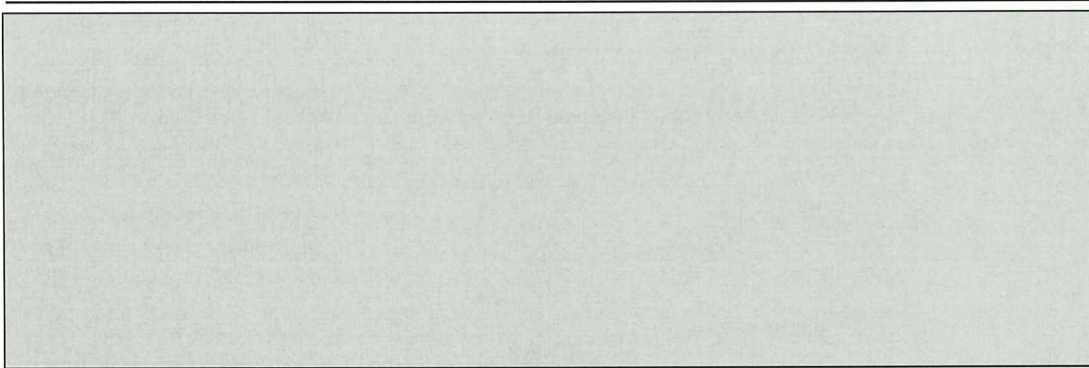

**MAIL NOTIFICATION:** Pursuant to Section 47-27.2 Types of Public Notice and 47-27.9 Variance, Special Exception, Temporary Non-Conforming Use, Interpretation requires the following notice:

- **MAIL NOTICE:** Mail notice shall be given to owners of land within three hundred (300) feet of the subject site ten (10) days prior to the date set for the public hearing.
  - **TAX MAP:** Applicant shall provide a tax map from the Broward County Property Appraiser of all property within a three hundred (300) foot radius, with each property clearly shown and delineated. Each property within the notice area must be numbered (by Folio ID) on the map to cross-reference with property owners notice list.
  - **PROPERTY OWNERS NOTICE LIST:** Applicant shall provide a property owners notice list with the names, property control numbers (Folio ID) and complete addresses for all property owners within the required three hundred (300) foot radius. The list shall also include all homeowners associations, condominium associations, municipalities and counties noticed, as indicated on the tax roll.
  - **ENVELOPES:** The applicant shall provide business size (#10) envelopes with first class postage attached (stamps only, metered mail will not be accepted). Envelopes must be addressed to all property owners within the required three hundred (300) foot radius, and mailing addresses must be typed or labeled; no handwritten addresses will be accepted. The return address shall be listed on all envelopes as follows:

City of Fort Lauderdale  
Urban Design & Development -BOA  
700 NW 19<sup>th</sup> Avenue, Fort Lauderdale, FL 33311.

- **DISTRIBUTION:** The City of Fort Lauderdale, Urban Design & Development will mail all notices prior to the public hearing meeting date, as outlined in Section 47-27.

Page 4: Sign Notification Requirements and Affidavit

SIGN NOTICE

Applicant must POST SIGNS (for Board of Adjustment) according to Sec. 47-27.2 Types of Public Notice and 47-27.9 Variance, Special Exception, Temporary Non-Conforming Use, Interpretation requires the following notice:

- Sign Notice shall be given by the applicant by posting a sign provided by the City stating the time, date and place of the Public Hearing on such matter on the property which is the subject of an application for a development permit. If more than one (1) public hearing is held on a matter, the date, time and place shall be stated on the sign or changed as applicable.
The sign shall be posted at least fifteen (15) days prior to the date of the public hearing.
The sign shall be visible from adjacent rights-of-way, including waterways, but excepting alleys.
If the subject property is on more than one (1) right-of-way, as described above, a sign shall be posted facing each right-of-way.
If the applicant is not the owner of the property that is subject of the application, the applicant shall post the sign on or as near to the subject property as possible subject to the permission of the owner of the property where the sign is located or, in a location in the right-of-way if approved by the City.
If the sign is destroyed or removed from the property, the applicant is responsible for obtaining another sign from the City and posting the sign on the property.
The sign shall remain on the property until final disposition of the application. This shall include any deferral, rehearing, appeal, request for review or hearings by another body. The sign information shall be changed as above to reflect any new dates.
The applicant shall, five (5) days prior to the public hearing, execute and submit to the department an affidavit of proof of posting of the public notice sign according to this section. If the applicant fails to submit the affidavit the public hearing will be postponed until the next hearing after the affidavit has been supplied.

AFFIDAVIT OF POSTING SIGNS

STATE OF FLORIDA

BROWARD COUNTY

BOA CASE NO. \_\_\_\_\_

APPLICANT: \_\_\_\_\_

PROPERTY: \_\_\_\_\_

PUBLIC HEARING DATE: \_\_\_\_\_

BEFORE ME, the undersigned authority, personally appeared \_\_\_\_\_, who upon being duly sworn and cautioned, under oath deposes and says:

- Affiant is the Applicant in the above cited City of Fort Lauderdale Board or Commission Case.
The Affiant/Applicant has posted or has caused to be posted on the Property the signage provided by the City of Fort Lauderdale, which such signage notifies the public of the time, date and place of the Public Hearing on the application for relief before the Board or Commission.
That the sign(s) referenced in Paragraph two (2) above was posted on the Property in such manner as to be visible from adjacent streets and waterways and was posted at least fifteen (15) days prior to the date of the Public Hearing cited above and has remained continuously posted until the date of execution and filing of this Affidavit. Said sign(s) shall be visible from and within twenty (20) feet of streets and waterways, and shall be securely fastened to a stake, fence, or building.
Affiant acknowledges that the sign must remain posted on the property until the final disposition of the case before the Board or Commission. Should the application be continued, deferred or re-heard, the sign shall be amended to reflect the new dates.
Affiant acknowledges that this Affidavit must be executed and filed with the City's Urban Design & Development five (5) calendar days prior to the date of Public Hearing and if the Affidavit is not submitted, the Public Hearing on this case shall be cancelled.
Affiant is familiar with the nature of an oath or affirmation and is familiar with the laws of perjury in the State of Florida and the penalties therefore.

NOTE: I understand that if my sign is not returned within the prescribed time limit as noted in Sec. 47.27.2.j of the City of Fort Lauderdale ULDR, I will forfeit my sign deposit. \_\_\_\_\_ (initial here)

Affiant

SWORN TO AND SUBSCRIBED before me in the County and State above aforesaid this \_\_\_\_\_ day of February \_\_\_\_\_, 20 21

(SEAL)

NOTARY PUBLIC
MY COMMISSION EXPIRES:

## Page 5: Technical Specifications

### A. SITE PLAN

1. Title Block including project name and design professional's address and phone number
2. Scale (1" = 30' min., must be engineer's scale)
3. North indicator
4. Location map showing relationship to major arterials
5. Drawing and revision dates, as applicable
6. Full legal description
7. Site Plan Data Table
  - Current use of property
  - Land Use designation
  - Zoning designation
  - Site area (sq. ft. and acres)
  - Setback table (required vs. provided)
  - Open space
8. Site Plan Features (graphically indicated)
  - Setbacks and building separations (dimensioned)
  - Project signage (if applicable)
  - Easements (as applicable)

(Please note additional site plan information may be necessary to fully address the requested variance)

### B. BUILDING ELEVATIONS (as applicable)

1. All building facades with directional labels (ie. North, South) and building names if more than one building
2. Dimensions, including height and width of all structures
3. Dimensions of setbacks and required setbacks from property lines
4. Dimension grade at crown of road, at curb, sidewalk, building entrance, and finished floor
5. Include proposed signage

# OLIVE | JUDD

February 8, 2021

**Via Hand Delivery**

City of Fort Lauderdale  
Department of Sustainable Development  
Urban Design & Planning Division  
700 NW 19<sup>th</sup> Avenue  
Fort Lauderdale, FL 33311

Re: Letter of Consent

To whom it may concern:

I, Benjamin E. Olive, Authorized Member of 2426 East Las Olas, LLC, owner of the property located at 2426 East Las Olas Blvd., Fort Lauderdale, FL consent to the submittal of the Application for Variance Applicant permitting the Applicant to move the northern exterior wall north a distance of 2.25 feet in the northwest section of the building. I authorize Kristy Armada to act on my behalf.

Thank you.

2426 East Las Olas, LLC

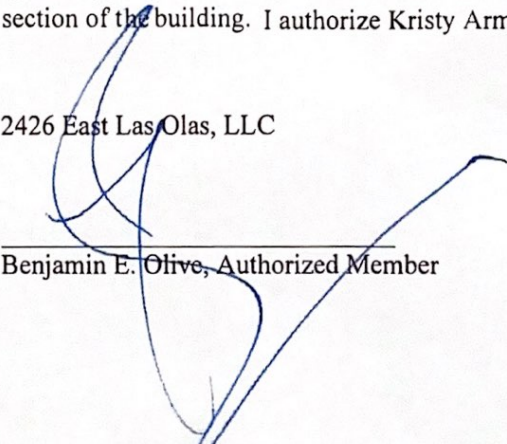
  
\_\_\_\_\_  
Benjamin E. Olive, Authorized Member

STATE OF FLORIDA     )  
  )  
COUNTY OF BROWARD    )

The foregoing instrument was acknowledged before me on February 8, 2021, by Benjamin E. Olive who is personally known to me and who did take an oath.

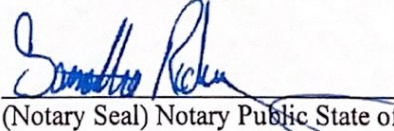
  
\_\_\_\_\_  
(Notary Seal) Notary Public State of Florida





**NOTICE AFFIDAVIT**

STATE OF FLORIDA, BROWARD COUNTY  
CITY OF FORT LAUDERDALE

PLN-BOA-21020001

BEFORE ME THIS DAY PERSONALLY APPEARED CHRISTINA MATHEWS  
WHO BEING DULY SWORN, DEPOSES AND SAYS:

1. The attached property owners list is, to the best of my knowledge, a complete and accurate list of all property owners, mailing addresses and property control numbers as recorded in the latest official tax rolls obtained from the Property Appraisers Office for all property within 300 feet of Portion of Portion of Lot 1, Lot 2 of Block 13 of Resub Blks 13 & 14 Idlewyld as recorded in Plat Book 7 Page 38 of the Public Records of Broward County, Florida. 2426 E. Las Olas Boulevard
2. The attached property owners list includes, to the best of my knowledge, all affected property owners, municipalities, counties, homeowner associations, and property owner associations in accordance with the requirements of the UDLR and the City of Fort Lauderdale.

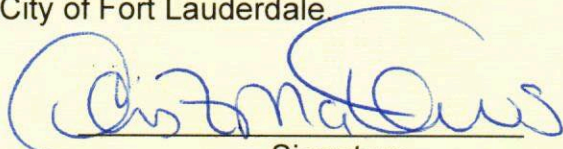
  
Signature

The foregoing instrument was acknowledged before me this 8<sup>th</sup> day of February, 2021.

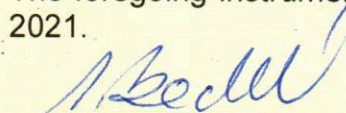
  
Signature of Person Taking Acknowledgement

  
Notary Public

Notary's Seal

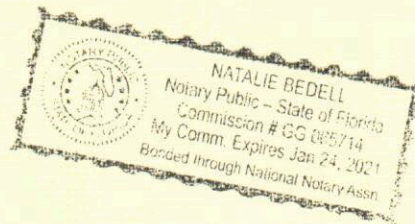

1025 Yale Drive  
Hollywood, Florida 33021  
954-920-2205  
Email: cutroplanning@yahoo.com

Prepared by and return to:

**FOGEL LAW GROUP**  
**2500 North Military Trail Suite 200**  
**Boca Raton, FL 33431**  
**561-393-9111**  
File Number: **13-1413.2**

Parcel Identification No. **504212050020**

Consideration: \$ 900,000.00

[Space Above This Line For Recording Data]

## Warranty Deed

(STATUTORY FORM - SECTION 689.02, F.S.)

**This Indenture** made this **28th** day of **August, 2013** between **Las Olas, LLC, an Illinois limited liability company** whose post office address is **1706 East Washington Street, Bloomington, IL 61701** of the County of **McLean, State of Illinois**, grantor\*, and **2426 East Las Olas, LLC, a Florida limited liability company** whose post office address is **2426 Las Olas Blvd, Fort Lauderdale, FL 33301** of the County of **Broward, State of Florida**, grantee\*,

**Witnesseth** that said grantor, for and in consideration of the sum of **TEN AND NO/100 DOLLARS (\$10.00)** and other good and valuable considerations to said grantor in hand paid by said grantee, the receipt whereof is hereby acknowledged, has granted, bargained, and sold to the said grantee, and grantee's heirs and assigns forever, the following described land, situate, lying and being in **Broward County, Florida**, to-wit:

**The West Twenty (20) feet of Lot One (1) and the East Thirty (30) feet of Lot 2, of a ReSubdivision of Blocks 13 and 14, and part of Block A of Idlewyld, according to the plat thereof, as recorded in Plat Book 7, Page 38, of the Public Records of Broward County, Florida.**

**Subject to taxes for 2013 and subsequent years; covenants, conditions, restrictions, easements, reservations and limitations of record, if any.**

and said grantor does hereby fully warrant the title to said land, and will defend the same against lawful claims of all persons whomsoever.

\* "Grantor" and "Grantee" are used for singular or plural, as context requires.

**In Witness Whereof**, grantor has hereunto set grantor's hand and seal the day and year first above written.

Signed, sealed and delivered in our presence:

Las Olas, LLC, an Illinois limited liability company

By: The Richard B. Owen Revocable Trust, its Manager

[Signature] Co-Trustee  
Brent Alsman, Co-Trustee

[Signature]  
Witness Name: John Lovelass

[Signature]  
Witness Name: BRYAN BEAUCHAMP

[Signature]  
Witness Name: John Lovelass

[Signature]  
Witness Name: DIANE BEAUCHAMP

[Signature] Co-Trustee  
Deanne Colledge, Co-Trustee

State of Illinois  
County of McLean

The foregoing instrument was acknowledged before me this 28th day of August, 2013 by Brent Alsman, Co-Trustee, who  is personally known or  has produced a driver's license as identification.

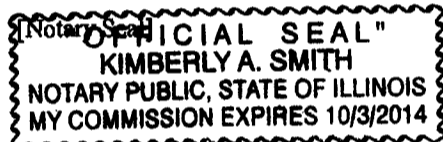

[Signature]  
Notary Public

Printed Name: Kimberly A. Smith

My Commission Expires: 10/3/2014

State of Illinois  
County of McLean

The foregoing instrument was acknowledged before me this 28th day of August, 2013 by Deanne Colledge, Co-Trustee, who  is personally known or  has produced a driver's license as identification.

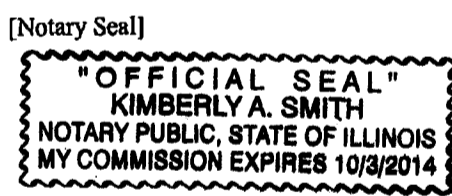

[Signature]  
Notary Public

Printed Name: Kimberly A. Smith

My Commission Expires: 10/3/2014

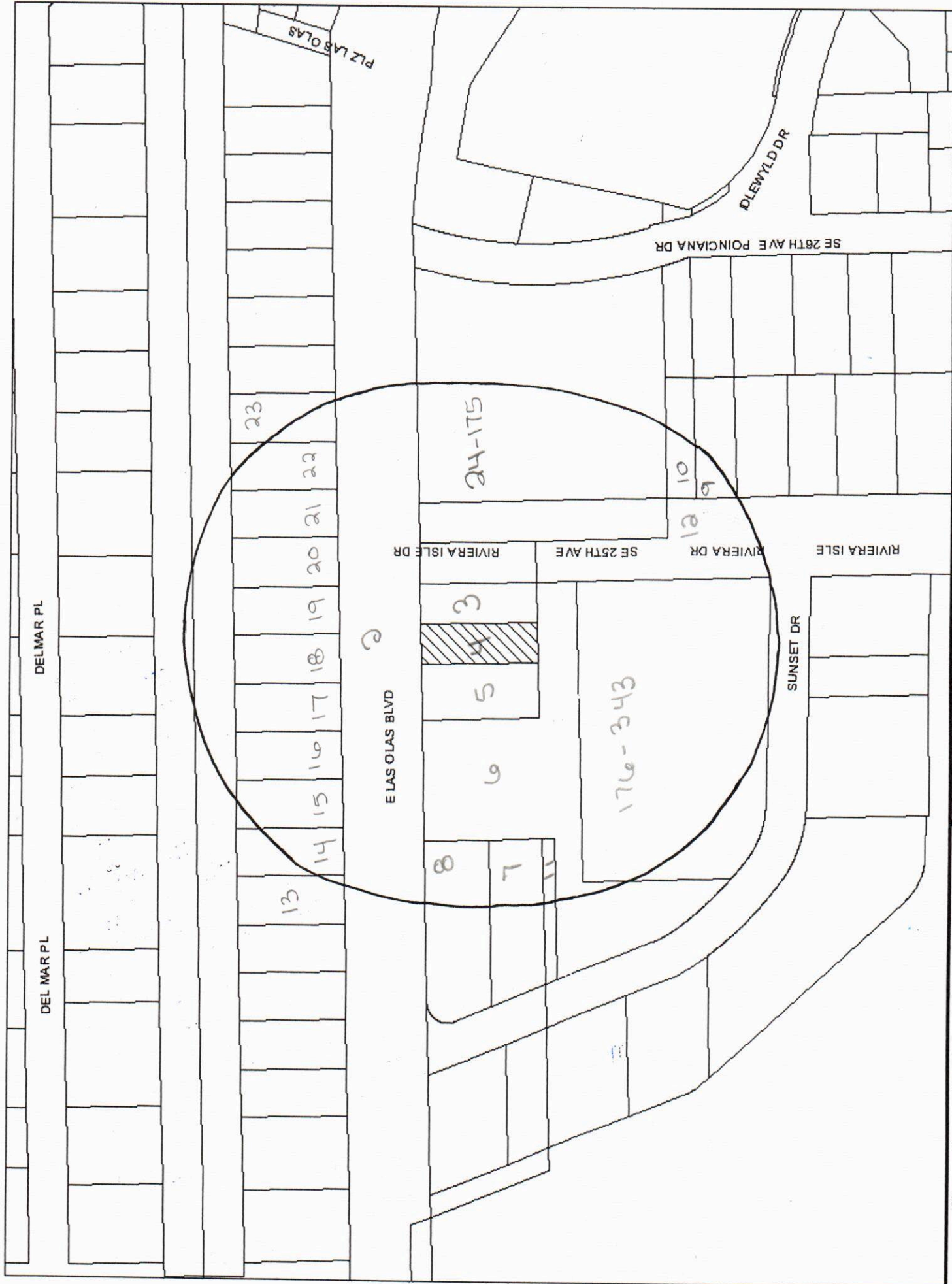

DEL MAR PL

DEL MAR PL

PLZ LAS OLAS

DLEWYLD DR

SE 26TH AVE POINCIANA DR

RIVIERA ISLE DR

SE 25TH AVE

RIVIERA DR

RIVIERA ISLE

E LAS OLAS BLVD

SUNSET DR

23

22

21

20

19

18

17

16

15

14

13

24-175

8

7

6

5

3

176-343

12

10

9



MARTY KIAR  
BROWARD COUNTY PROPERTY APPRAISER

MARTY KIAR  
BROWARD COUNTY PROPERTY APPRAISER

2426 E Las Olas Blvd



	A	B	C	D	E	F	G	H
1	FOLIO_NUMB	NAME	ADDRESS_LI	CITY	STATE	ZIP	ZIP4	LEGAL
2	504212000100	CITY OF FORT LAUDERDALE	100 N ANDREWS AVE	FORT LAUDERDALE	FL	33301		12-50-42PORTIONS OF LAS OLAS BOULEVARDFROM E R/W/L OF SE 16 AVE TO W/LOF INTRACOASTAL WATERWAY AS PERR/W MAP 15-194 BCR
3	504212050010	2436 EAST LAS OLAS BLVDSTORES LLC	PO BOX 1910	WATERBURY	CT	06722		RESUB BLKS 13 & 14 IDLEWYLD7-38 BLOT 1 E 50 BLK 13
4	504212050020	2426 EAST LAS OLAS LLC	2426 E LAS OLAS BLVD	FORT LAUDERDALE	FL	33301		RESUB BLKS 13 & 14 IDLEWYLD7-38 BLOT 1 LESS E 50 & E 30 OFLOT 2 BLK 13
5	504212050030	FT LAUDERDALE LAND HOLDINGS LLC	800 E PALMETTO PARK ROAD	BOCA RATON	FL	33432		RESUB BLKS 13 & 14 IDLEWYLD7-38 BLOT 2 W 20,3 BLK 13
6	504212050040	IDLEWOOD PLACE LLC	1770 NW 64 ST #400	FORT LAUDERDALE	FL	33309		RESUB BLKS 13 & 14 IDLEWYLD7-38 BLOT 4 TO 6 BLK 13 TOGET WITHLOT 5;N 50 OF LOTS 6 TO 8;THATPT OF LOTS 9 & 10 LYING W OF ALINE 374 W OF & PARA WITH E/L OFBLK 10;LOT 11 LESS E 54;ANDLOT 12 S 35 BLK 10 OF RIVIERA6-17 B
7	504212050050	AUDY UNISON LLC	PO BOX 402687	MIAMI BEACH	FL	33140		RESUB BLKS 13 & 14 IDLEWYLD7-38 BALL LOTS 7 TO 10,LESS N 81BLK 13
8	504212060010	BADWED INC	2366 E LAS OLAS BLVD	FORT LAUDERDALE	FL	33301	1527	IDLEWYLD-AMEN PLAT OF A PORTIONOF BLK 13 41-35 BLOT 1 & 2
9	504212081320	REDICK,STANLEY JRSMITH,LISA K	328 RIVIERA ISLE DR	FORT LAUDERDALE	FL	33301	2612	RIVIERA 6-17 BLOT 9 BLK 9
10	504212081330	RICHARDSON,WILLIE F JR	324 RIVIERA ISLE DR	FORT LAUDERDALE	FL	33301	2612	RIVIERA 6-17 BLOT 10 LESS N 15 BLK 9
11	504212081471	AUDY UNISON LLC	PO BOX 402687	MIAMI BEACH	FL	33140	0687	RIVIERALOT 12 LESS S 35 BLK 10
12	504212081530	PUBLIC LAND% CITY OF FORT LAUDERDALE	100 N ANDREWS AVE	FORT LAUDERDALE	FL	33301		RIVIERA 6-17 BROAD RIGHTS OF WAY AS DEDICATEDPER PLAT LESS P/P/A KENTS ISLAND15-22B, P/P/A RIVIERA AM PL LOTS1-4,BLK 3 26-38B,AND LESS P/P/ACROYDON POINT 15-28 B, AND LESSPOR OF VAC'D SE 5TH ST PER OR17411/634
13	504212120070	HAINES,STEVEN & DEBBIE	2405 E LAS OLAS BLVD	FORT LAUDERDALE	FL	33301	1572	LAUDERDALE SHORES CORR PLATBLK 1 15-25 BLOT 8 BLK 1
14	504212120080	MURPHY,RAYMOND L & VIVIAN A	2409 E LAS OLAS BLVD	FORT LAUDERDALE	FL	33301	1572	LAUDERDALE SHORES CORR PLATBLK 1 15-25 BLOT 9 BLK 1
15	504212120090	ZACHARY A NECUZE HOMESTEAD TRPEREZ,LUIS A TRSTEE	5901 SW 74 ST STE 211	SOUTH MIAMI	FL	33141		LAUDERDALE SHORES CORR PLATBLK 1 15-25 BLOT 10 BLK 1
16	504212120100	MARGOLIN SULIMANY LLCMAZAR HOMES LLC	8320 W SUNRISE BLVD #207	PLANTATION	FL	33322		LAUDERDALE SHORES CORR PLATBLK 1 15-25 BLOT 11 BLK 1
17	504212120110	MALONE,ADAM	8880 HUNTCLIFF TER	ATLANTA	GA	30350		LAUDERDALE SHORES CORR PLATBLK 1 15-25 BLOT 12 BLK 1
18	504212120120	OATES,BEVERLEY C	2425 E LAS OLAS BLVD	FORT LAUDERDALE	FL	33301	1572	LAUDERDALE SHORES CORR PLATBLK 1 15-25 BLOT 13 BLK 1
19	504212120130	BERNE,EVELYN GONZALEZ	2429 E LAS OLAS BLVD	FORT LAUDERDALE	FL	33301		LAUDERDALE SHORES CORR PLATBLK 1 15-25 BLOT 14 BLK 1
20	504212120140	DOTOLI,JOSHUA EVAN H/ESUSTERMAN,DAYANA	2431 E LAS OLAS BLVD	FORT LAUDERDALE	FL	33301	1572	LAUDERDALE SHORES CORR PLATBLK 1 15-25 BLOT 15 BLK 1
21	504212120150	MARX,WILLIAM HSCHULMAN,BARBARA N	2451 E LAS OLAS BLVD	FORT LAUDERDALE	FL	33301	1572	LAUDERDALE SHORES CORR PLATBLK 1 15-25 BLOT 16 BLK 1
22	504212120160	WEINBAUM,MARGARITA	2505 E LAS OLAS BLVD	FORT LAUDERDALE	FL	33301		LAUDERDALE SHORES CORR PLATBLK 1 15-25 BLOT 17 BLK 1
23	504212120170	MADER,HEIDI KSTANLEY,RICHARD J	2513 E LAS OLAS BLVD	FORT LAUDERDALE	FL	33301		LAUDERDALE SHORES CORR PLATBLK 1 15-25 BLOT 18 BLK 1
24	504212AH0010	PETRESCU,ELIZA	530 E 76 ST APT 7G	NEW YORK	NY	10021	3144	MARINE TOWER CONDOUNIT 301PER CDO BK/PG: 4152/306
25	504212AH0020	SPRINGER,JAY A & MARIA M	2500 E LAS OLAS BLVD #302	FORT LAUDERDALE	FL	33301		MARINE TOWER CONDOUNIT 302PER CDO BK/PG: 4152/306
26	504212AH0030	DUNCAN,VICTOR	2500 EAST LAS OLAS BLVD #303	FORT LAUDERDALE	FL	33301		MARINE TOWER CONDOUNIT 303PER CDO BK/PG: 4152/306
27	504212AH0040	ZAYAS,LUIS EDGARDO	2500 E LAS OLAS BLVD #304	FORT LAUDERDALE	FL	33301		MARINE TOWER CONDOUNIT 304PER CDO BK/PG: 4152/306
28	504212AH0050	KAD TRHOVATER,THOMAS TRSTEE	3528 S TURKEYFOOT RD	COVENTRY TOWNSHIP	OH	44319	2938	MARINE TOWER CONDOUNIT 305PER CDO BK/PG: 4152/306
29	504212AH0060	MANELAS,JOHN T JR	2500 E LAS OLAS BLVD #306	FORT LAUDERDALE	FL	33301		MARINE TOWER CONDOUNIT 306PER CDO BK/PG: 4152/306

	A	B	C	D	E	F	G	H
30	504212AH0070	GELB,EVELYNMELVIN GELB TR ETAL	2500 E LAS OLAS BLVD APT 307	FORT LAUDERDALE	FL	33301	1585	MARINE TOWER CONDOUNIT 307PER CDO BK/PG: 4152/306
31	504212AH0080	BAUER,LINDA M H/EGARCIA-VALENTIE,CARLOS A	2500 E LAS OLAS BLVD #308	FORT LAUDERDALE	FL	33301	1585	MARINE TOWER CONDOUNIT 308PER CDO BK/PG: 4152/306
32	504212AH0090	SLAYTON,JOHN R	2500 E LAS OLAS BLVD #309	FORT LAUDERDALE	FL	33301		MARINE TOWER CONDOUNIT 309PER CDO BK/PG: 4152/306
33	504212AH0100	WELLS,SUSANSUSAN WELLS REV LIVTR	2500 E LAS OLAS BLVD #401	FORT LAUDERDALE	FL	33301		MARINE TOWER CONDOUNIT 401PER CDO BK/PG: 4152/306
34	504212AH0110	MANELAS,JOHN T JR	2500 E LAS OLAS BLVD #402	FORT LAUDERDALE	FL	33301		MARINE TOWER CONDOUNIT 402PER CDO BK/PG: 4152/306
35	504212AH0120	LIESER,JAMES TKINA,SATOSHI ETAL	2500 E LAS OLAS BLVD #403	FORT LAUDERDALE	FL	33301		MARINE TOWER CONDOUNIT 403PER CDO BK/PG: 4152/306
36	504212AH0130	BOUNDS,DARLENE F	2500 E LAS OLAS BLVD #404	FORT LAUDERDALE	FL	33301	1585	MARINE TOWER CONDOUNIT 404PER CDO BK/PG: 4152/306
37	504212AH0140	WETZEL,DUANE W JRWETZEL,RENE M	817 GARDENSTONE CIR	TALLMADGE	OH	44278	1085	MARINE TOWER CONDOUNIT 405PER CDO BK/PG: 4152/306
38	504212AH0150	BOBBING,ERNEST J	2500 E LAS OLAS BLVD #406	FORT LAUDERDALE	FL	33301		MARINE TOWER CONDOUNIT 406PER CDO BK/PG: 4152/306
39	504212AH0160	LAMOUREUX,MICHAEL A	900 N KINGSBURY ST APT 839	CHICAGO	IL	60610	7439	MARINE TOWER CONDOUNIT 407PER CDO BK/PG: 4152/306
40	504212AH0170	WHICKER,CATHERINE	1570 SW 115 AVE	DAVIE	FL	33325		MARINE TOWER CONDOUNIT 408PER CDO BK/PG: 4152/306
41	504212AH0180	GUSTAFSON,JOEL K H/EGUSTAFSON,JUDYTH F	2500 E LAS OLAS BLVD #409	FORT LAUDERDALE	FL	33301		MARINE TOWER CONDOUNIT 409PER CDO BK/PG: 4152/306
42	504212AH0190	BLANCO,EDGARD R	2500 E LAS OLAS BLVD APT 501	FORT LAUDERDALE	FL	33301	1585	MARINE TOWER CONDOUNIT 501PER CDO BK/PG: 4152/306
43	504212AH0200	KING,SHARONSHARON KING REV TR	2500 E LAS OLAS BLVD UNIT 502	FORT LAUDERDALE	FL	33301	1585	MARINE TOWER CONDOUNIT 502PER CDO BK/PG: 4152/306
44	504212AH0210	SHARPLEY,MAIA	2500 E LAS OLAS BLVD #503	FORT LAUDERDALE	FL	33301		MARINE TOWER CONDOUNIT 503PER CDO BK/PG: 4152/306
45	504212AH0220	CUMMINGS,JOHNNANINO,JUDY MONT	2500 E LAS OLAS BLVD UNIT 504	FORT LAUDERDALE	FL	33301	1585	MARINE TOWER CONDOUNIT 504PER CDO BK/PG: 4152/306
46	504212AH0230	BECKETT,KENNETH	2500 E LAS OLAS BLVD #505	FORT LAUDERDALE	FL	33301		MARINE TOWER CONDOUNIT 505PER CDO BK/PG: 4152/306
47	504212AH0240	CHINNOCK,PHILLIP EKELLY,CYNTHIA L	2500 E LAS OLAS BLVD #506	FORT LAUDERDALE	FL	33301		MARINE TOWER CONDOUNIT 506PER CDO BK/PG: 4152/306
48	504212AH0250	KLEPPINGER,DENISESIERRA,SCOTT E	167 MCLEAN AVE	MANASQUAN	NJ	08736		MARINE TOWER CONDOUNIT 507PER CDO BK/PG: 4152/306
49	504212AH0260	MANELAS,JOHN T JR	2500 E LAS OLAS BLVD APT 402	FORT LAUDERDALE	FL	33301	1585	MARINE TOWER CONDOUNIT 508PER CDO BK/PG: 4152/306
50	504212AH0270	PICCININNI,NICOLETTE H/EPICCININNI FAM REV TR ETAL	2500 E LAS OLAS BLVD #509	FORT LAUDERDALE	FL	33301		MARINE TOWER CONDOUNIT 509PER CDO BK/PG: 4152/306
51	504212AH0280	JOHNSON 2014 FAM TRJOHNSON,ROBERT & ELIZABETH TRSTE	3435 GENTRY RD	IRVING	TX	75062		MARINE TOWER CONDOUNIT 601PER CDO BK/PG: 4152/306
52	504212AH0290	SANDER,DOROTHY E	2500 E LAS OLAS BLVD #602	FORT LAUDERDALE	FL	33301	1585	MARINE TOWER CONDOUNIT 602PER CDO BK/PG: 4152/306
53	504212AH0300	BAILEY,JUSTIN	2500 E LAS OLAS BLVD #603	FORT LAUDERDALE	FL	33301		MARINE TOWER CONDOUNIT 603PER CDO BK/PG: 4152/306
54	504212AH0310	ROSEN,ILANA LYNN	2500 E LAS OLAS BLVD #604	FORT LAUDERDALE	FL	33301		MARINE TOWER CONDOUNIT 604PER CDO BK/PG: 4152/306
55	504212AH0320	ALEXANDER,JOAN H/EBATCHELOR,JOSEPH ETAL	43 MARTINDALE RD	ASHEVILLE	NC	28804	1427	MARINE TOWER CONDOUNIT 605PER CDO BK/PG: 4152/306
56	504212AH0330	MCCANN,EZRA N & BETTY J	2500 E LAS OLAS BLVD #606	FORT LAUDERDALE	FL	33301		MARINE TOWER CONDOUNIT 606PER CDO BK/PG: 4152/306
57	504212AH0340	THORNTON,STEVEN ATHORNTON,CONSTANCE	2500 E LAS OLAS BLVD #607	FORT LAUDERDALE	FL	33301		MARINE TOWER CONDOUNIT 607PER CDO BK/PG: 4152/306
58	504212AH0350	TAYLOR,WILLIAM L	2500 E LAS OLAS BLVD # 608	FORT LAUDERDALE	FL	33301		MARINE TOWER CONDOUNIT 608PER CDO BK/PG: 4152/306
59	504212AH0360	WINDLE,JONATHAN CJ C WINDLE REV MARYLAND TR	2500 E LAS OLAS BLVD #609	FORT LAUDERDALE	FL	33301		MARINE TOWER CONDOUNIT 609PER CDO BK/PG: 4152/306
60	504212AH0370	MAHER,JOHN F & LOU ANN H/EMAHER,SHERYL ANN	2500 E LAS OLAS BLVD #701	FORT LAUDERDALE	FL	33301		MARINE TOWER CONDOUNIT 701PER CDO BK/PG: 4152/306

	A	B	C	D	E	F	G	H
61	504212AH0380	SULLIVAN,SUSAN WERTMAN	2500 E LAS OLAS BLVD #702	FORT LAUDERDALE	FL	33301		MARINE TOWER CONDOUNIT 702PER CDO BK/PG: 4152/306
62	504212AH0390	KOERWER,W RUSSELL &SCHREIBER,STEPHEN F	2500 E LAS OLAS BLVD #703	FORT LAUDERDALE	FL	33301		MARINE TOWER CONDOUNIT 703PER CDO BK/PG: 4152/306
63	504212AH0400	RODRIGO,ELIZABETH & JAIME E	2500 E LAS OLAS BLVD #704	FORT LAUDERDALE	FL	33301		MARINE TOWER CONDOUNIT 704PER CDO BK/PG: 4152/306
64	504212AH0410	GOMEZ,MARIELLA TMARIELLA T GOMEZ REV TR	2500 E LAS OLAS BOULEVARD 705	FORT LAUDERDALE	FL	33301	1581	MARINE TOWER CONDOUNIT 705PER CDO BK/PG: 4152/306
65	504212AH0420	FERCHAK,WILLIAM A	2500 E LAS OLAS BLVD UNIT 706	FORT LAUDERDALE	FL	33301		MARINE TOWER CONDOUNIT 706PER CDO BK/PG: 4152/306
66	504212AH0430	REAGAN,ROBERT J	2500 E LAS OLAS BLVD #707	FORT LAUDERDALE	FL	33301		MARINE TOWER CONDOUNIT 707PER CDO BK/PG: 4152/306
67	504212AH0440	FOLEY,SUSAN BSUSAN B FOLEY EXEMPT TR	2500 E LAS OLAS BLVD UNIT 708	FORT LAUDERDALE	FL	33301		MARINE TOWER CONDOUNIT 708PER CDO BK/PG: 4152/306
68	504212AH0450	SAMELA,DANIEL JR	2500 E LAS OLAS BLVD #709	FORT LAUDERDALE	FL	33301		MARINE TOWER CONDOUNIT 709PER CDO BK/PG: 4152/306
69	504212AH0460	GRAY,SAMUEL IIITHOMAS,H WILLIAM JR	1009 WILKINS HEIGHTS RD	PITTSBURGH	PA	15217		MARINE TOWER CONDOUNIT 801PER CDO BK/PG: 4152/306
70	504212AH0470	ASBAGHI,MICHAEL A H/ELEVINE,ELANA S	2500 E LAS OLAS BLVD #802	FORT LAUDERDALE	FL	33301		MARINE TOWER CONDOUNIT 802PER CDO BK/PG: 4152/306
71	504212AH0480	GEOFFREY,JOEL	3000 HOLIDAY DR APT 402	FORT LAUDERDALE	FL	33316	2455	MARINE TOWER CONDOUNIT 803PER CDO BK/PG: 4152/306
72	504212AH0490	BOSE,ANJANA	2500 E LAS OLAS BLVD #804	FORT LAUDERDALE	FL	33301	1586	MARINE TOWER CONDOUNIT 804PER CDO BK/PG: 4152/306
73	504212AH0500	JONES,JEFFREY & DEBRA	2500 E LAS OLAS BLVD #805	FORT LAUDERDALE	FL	33301		MARINE TOWER CONDOUNIT 805PER CDO BK/PG: 4152/306
74	504212AH0510	ORLANDO,FRANK AFRANK A ORLANDO TR	325 SUNSET DR UNIT B	FORT LAUDERDALE	FL	33304		MARINE TOWER CONDOUNIT 806PER CDO BK/PG: 4152/306
75	504212AH0520	SILBERSTEIN,MARION & JOSHUAMARION SILBERSTEIN LIV TR	2500 E LAS OLAS BLVD #807	FORT LAUDERDALE	FL	33301		MARINE TOWER CONDOUNIT 807PER CDO BK/PG: 4152/306
76	504212AH0530	MAFFIA,SALVATORE FMAFFIA,CAMILLE	777 PELHAM RD APT 4G	NEW ROCHELLE	NY	10805		MARINE TOWER CONDOUNIT 808PER CDO BK/PG: 4152/306
77	504212AH0540	MURPHY,PILAR H/ENOVITCH,PAUL	2500 E LAS OLAS BLVD # 809	FORT LAUDERDALE	FL	33301		MARINE TOWER CONDOUNIT 809PER CDO BK/PG: 4152/306
78	504212AH0550	MARCOVECCHIO,NICKMARCOVECCHIO,FRANCES	PO BOX 219	*RUTHVEN ON	CA	N0P 2	G0	MARINE TOWER CONDOUNIT 901PER CDO BK/PG: 4152/306
79	504212AH0560	SIMONTON,SUSAN	2500 E LAS OLAS BLVD #902	FORT LAUDERDALE	FL	33301		MARINE TOWER CONDOUNIT 902PER CDO BK/PG: 4152/306
80	504212AH0570	MANNING,KATHLEENKATHLEEN MANNING TR	2500 E LAS OLAS BLVD #903	FORT LAUDERDALE	FL	33301		MARINE TOWER CONDOUNIT 903PER CDO BK/PG: 4152/306
81	504212AH0580	MORONEY,JEANNE	2500 E LAS OLAS BLVD #904	FORT LAUDERDALE	FL	33301	1586	MARINE TOWER CONDOUNIT 904PER CDO BK/PG: 4152/306
82	504212AH0590	LUTHI,ROSANGELA	2500 E LAS OLAS BLVD #905	FORT LAUDERDALE	FL	33301		MARINE TOWER CONDOUNIT 905PER CDO BK/PG: 4152/306
83	504212AH0600	SCARABELLI,ALBERTO & ANNE	2500 E LAS OLAS BLVD APT 906	FORT LAUDERDALE	FL	33301		MARINE TOWER CONDOUNIT 906PER CDO BK/PG: 4152/306
84	504212AH0610	MT WAVES 907 LLC	114 VISTA TER	SOUTH MAHOPAC	NY	10541		MARINE TOWER CONDOUNIT 907PER CDO BK/PG: 4152/306
85	504212AH0620	PENA,JORGE EJORGE E PENA REV LIV TR	2500 E LAS OLAS BLVD #908	FORT LAUDERDALE	FL	33301		MARINE TOWER CONDOUNIT 908PER CDO BK/PG: 4152/306
86	504212AH0630	PEREZ-RIVAS,JOSE F & JUDITH AJOSE F & JUDITH A PEREZ-RIVAS TR	2500 E LAS OLAS BLVD #909	FORT LAUDERDALE	FL	33301		MARINE TOWER CONDOUNIT 909PER CDO BK/PG: 4152/306
87	504212AH0640	NELSON,DOROTHEA D	PO BOX 379	HOLLIDAYSBURG	PA	16648	0379	MARINE TOWER CONDOUNIT 1001PER CDO BK/PG: 4152/306
88	504212AH0650	GIUSTI,ANNE MARIEANNE MARIE GIUSTI TR	2500 E LAS OLAS BLVD #1002	FORT LAUDERDALE	FL	33301		MARINE TOWER CONDOUNIT 1002PER CDO BK/PG: 4152/306
89	504212AH0660	INGLESE,RICHARD D	2500 E LAS OLAS BLVD #1003	FORT LAUDERDALE	FL	33301		MARINE TOWER CONDOUNIT 1003PER CDO BK/PG: 4152/306
90	504212AH0670	JAMES E HARTMAN LIV TRHARTMAN,JAMES E TRSTEE	2500 E LAS OLAS BLVD APT 1004	FORT LAUDERDALE	FL	33301	1586	MARINE TOWER CONDOUNIT 1004PER CDO BK/PG: 4152/306
91	504212AH0680	LVM III NON EXEMPT TRMCNUTT,LEE WILLIAM III TRSTEE	3716 MCFARLIN BLVD	DALLAS	TX	75205		MARINE TOWER CONDOUNIT 1005PER CDO BK/PG: 4152/306

	A	B	C	D	E	F	G	H
92	504212AH0690	WARNER,AARON G & CHERLYN	2500 E LAS OLAS BLVD #1006	FORT LAUDERDALE	FL	33301		MARINE TOWER CONDOUNIT 1006PER CDO BK/PG: 4152/306
93	504212AH0700	GUSTAFSON,KIMBERLY ANN	2500 E LAS OLAS BLVD #1007	FORT LAUDERDALE	FL	33301		MARINE TOWER CONDOUNIT 1007PER CDO BK/PG: 4152/306
94	504212AH0710	STANTON,DIANE TROGER & DIANE STANTON REV TR	2500 E LAS OLAS BLVD #1008	FORT LAUDERDALE	FL	33301		MARINE TOWER CONDOUNIT 1008PER CDO BK/PG: 4152/306
95	504212AH0720	LICHTSHEIN,GIL	2500 E LAS OLAS BLVD #1009	FORT LAUDERDALE	FL	33301		MARINE TOWER CONDOUNIT 1009PER CDO BK/PG: 4152/306
96	504212AH0730	PETERSON,RODNEY M & KATHY J	2500 E LAS OLAS BLVD #1101	FORT LAUDERDALE	FL	33301		MARINE TOWER CONDOUNIT 1101PER CDO BK/PG: 4152/306
97	504212AH0740	RICE,CINDY L	10874 MARIAM LN	DAYTON	OH	45458		MARINE TOWER CONDOUNIT 1102PER CDO BK/PG: 4152/306
98	504212AH0750	LOWENBERG,ROBERT H	2500 E LAS OLAS BLVD APT 1103	FORT LAUDERDALE	FL	33301	1586	MARINE TOWER CONDOUNIT 1103PER CDO BK/PG: 4152/306
99	504212AH0760	BLAIR,PENELOPE JPENELOPE J BLAIR REV TR	2500 E LAS OLAS BLVD #1104	FORT LAUDERDALE	FL	33301	1586	MARINE TOWER CONDOUNIT 1104PER CDO BK/PG: 4152/306
100	504212AH0770	GAFFNEY,MAJORIE	7300 DEARWESTER DR APT 148	CINCINNATI	OH	45236	6109	MARINE TOWER CONDOUNIT 1105PER CDO BK/PG: 4152/306
101	504212AH0780	QUARTIN,PATTIPATTI A QUARTIN REV LIV TR	2500 E LAS OLAS BLVD APT 1106	FORT LAUDERDALE	FL	33301	1587	MARINE TOWER CONDOUNIT 1106PER CDO BK/PG: 4152/306
102	504212AH0790	HOLSHOUSER,JESSE III &HOLSHOUSER,PATRICIA	1819 SE 17 ST #809	FORT LAUDERDALE	FL	33316		MARINE TOWER CONDOUNIT 1107PER CDO BK/PG: 4152/306
103	504212AH0800	WASERSTEIN,NICKYNICKY WASERSTEIN REV TR	2500 E LAS OLAS BLVD #1108	FORT LAUDERDALE	FL	33301		MARINE TOWER CONDOUNIT 1108PER CDO BK/PG: 4152/306
104	504212AH0810	BABINEC,JOHN P	2500 E LAS OLAS BLVD #1109	FORT LAUDERDALE	FL	33301		MARINE TOWER CONDOUNIT 1109PER CDO BK/PG: 4152/306
105	504212AH0820	SPECIALE,CESARE A	2500 E LAS OLAS BLVD #1201	FORT LAUDERDALE	FL	33301		MARINE TOWER CONDOUNIT 1201PER CDO BK/PG: 4152/306
106	504212AH0830	SHAEFFER,DOUGLAS J & LISA B	2500 E LAS OLAS BLVD APT 1202	FORT LAUDERDALE	FL	33301	1587	MARINE TOWER CONDOUNIT 1202PER CDO BK/PG: 4152/306
107	504212AH0840	FERGUSON,SCOTTSCOTT M FERGUSON REV TR	2500 E LAS OLAS BLVD #1203	FORT LAUDERDALE	FL	33301		MARINE TOWER CONDOUNIT 1203PER CDO BK/PG: 4152/306
108	504212AH0850	LAS REV TRSNEAD,LISA ANN TRSTEE	3737 YATES ST	DENVER	CO	80212		MARINE TOWER CONDOUNIT 1204PER CDO BK/PG: 4152/306
109	504212AH0860	COYNE,JAMES &MCGILL-COYNE,JACQUELINE	7 I STREET	SOUTH BOSTON	MA	02127		MARINE TOWER CONDOUNIT 1205PER CDO BK/PG: 4152/306
110	504212AH0870	KAD TRHOVATER,THOMAS D TRSTEE	3528 S TURKEYFOOT RD	COVENTRY TOWNSHIP	OH	44319	2938	MARINE TOWER CONDOUNIT 1206PER CDO BK/PG: 4152/306
111	504212AH0880	BOSTROM,ANDERS & EVA	KLOSTERVAGEN 6 132 46	*SALTSJO BOO	SE			MARINE TOWER CONDOUNIT 1207PER CDO BK/PG: 4152/306
112	504212AH0890	SEIDLIN,LARRY S & BELINDA	2500 E LAS OLAS BLVD APT 1208	FORT LAUDERDALE	FL	33301	1587	MARINE TOWER CONDOUNIT 1208PER CDO BK/PG: 4152/306
113	504212AH0900	CASSEL,MARY ANNMARY ANN CASSEL LIV TR	1031 SEMINOLE DR APT 1134	FORT LAUDERDALE	FL	33304	3250	MARINE TOWER CONDOUNIT 1209PER CDO BK/PG: 4152/306
114	504212AH0910	LOUISE FARM ENTERPRISES LLC	2500 E LAS OLAS BLVD #1401	FORT LAUDERDALE	FL	33301		MARINE TOWER CONDOUNIT 1401PER CDO BK/PG: 4152/306
115	504212AH0920	BROTT,RICHARD WSHASKY,MICHAEL	2500 E LAS OLAS BLVD #1402	FORT LAUDERDALE	FL	33301	1587	MARINE TOWER CONDOUNIT 1402PER CDO BK/PG: 4152/306
116	504212AH0930	LOUISE FARM ENTERPRISES LLC	2500 E LAS OLAS BLVD #1401	FORT LAUDERDALE	FL	33301		MARINE TOWER CONDOUNIT 1403PER CDO BK/PG: 4152/306
117	504212AH0940	ROBERTS,JAY A &ROBERTS,MARGARET E	2500 E LAS OLAS BLVD APT 1404	FORT LAUDERDALE	FL	33301	1587	MARINE TOWER CONDOUNIT 1404PER CDO BK/PG: 4152/306
118	504212AH0950	LOUISE FARM ENTERPRISES LLC	2500 E LAS OLAS BLVD #1401	FORT LAUDERDALE	FL	33301		MARINE TOWER CONDOUNIT 1405PER CDO BK/PG: 4152/306
119	504212AH0960	GIGLIA,JAMES P & DEBRA ANNJAMES P & DEBRA A GIGLIA REV TR	2500 E LAS OLAS BLVD # 1406	FORT LAUDERDALE	FL	33301		MARINE TOWER CONDOUNIT 1406PER CDO BK/PG: 4152/306
120	504212AH0970	SCOBIE,LOIS J	2500 E LAS OLAS BLVD UNIT 1407	FORT LAUDERDALE	FL	33301		MARINE TOWER CONDOUNIT 1407PER CDO BK/PG: 4152/306
121	504212AH0980	JAMES P & DEBRA ANN GIGLIA TRGIGLIA,JAMES P & DEBRA A TRSTEEES	2500 E LAS OLAS BLVD #1406	FORT LAUDERDALE	FL	33301		MARINE TOWER CONDOUNIT 1408PER CDO BK/PG: 4152/306
122	504212AH0990	PARETI,SHARON L	2500 E LAS OLAS BLVD #1409	FORT LAUDERDALE	FL	33301		MARINE TOWER CONDOUNIT 1409PER CDO BK/PG: 4152/306

	A	B	C	D	E	F	G	H
123	504212AH1000	ELIOT,CHARLES CCHARLES C ELIOT REV TR	2500 E LAS OLAS BLVD #1501	FORT LAUDERDALE	FL	33301	1587	MARINE TOWER CONDOUNIT 1501 & 1502PER CDO BK/PG: 4152/306
124	504212AH1020	LWM III NON EXEMPT TRMCNUTT,LEE WILLIAM III TRSTEE	3716 MCFARLIN BLVD	DALLAS	TX	75205		MARINE TOWER CONDOUNIT 1503PER CDO BK/PG: 4152/306
125	504212AH1030	PROBECK,CYNTHIA	2500 E LAS OLAS BLVD #1504	FORT LAUDERDALE	FL	33301		MARINE TOWER CONDOUNIT 1504PER CDO BK/PG: 4152/306
126	504212AH1040	RUPPE,JAMES A	2500 EAST LAS OLAS BLVD	FORT LAUDERDALE	FL	33301	1508	MARINE TOWER CONDOUNIT 1505PER CDO BK/PG: 4152/306
127	504212AH1050	PATTI,CATHERINE & CHARLES	2500 E LAS OLAS BLVD #1506	FORT LAUDERDALE	FL	33301		MARINE TOWER CONDOUNIT 1506PER CDO BK/PG: 4152/306
128	504212AH1060	FREDD,GLORIA & STEPHEN	2500 E LAS OLAS BLVD APT 1507	FORT LAUDERDALE	FL	33301		MARINE TOWER CONDOUNIT 1507PER CDO BK/PG: 4152/306
129	504212AH1070	BERETTA,JOHN DJOHN D BERETTA REV TR	2500 E LAS OLAS BLVD UNIT 1508	FORT LAUDERDALE	FL	33301	1583	MARINE TOWER CONDOUNIT 1508PER CDO BK/PG: 4152/306
130	504212AH1080	COTRONE,CARLO M	2500 E LAS OLAS BLVD APT 1509	FORT LAUDERDALE	FL	33301		MARINE TOWER CONDOUNIT 1509PER CDO BK/PG: 4152/306
131	504212AH1090	SMITH,JILL BLAKE & GERALD R	2500 E LAS OLAS BLVD APT 1601	FORT LAUDERDALE	FL	33301	1583	MARINE TOWER CONDOUNIT 1601PER CDO BK/PG: 4152/306
132	504212AH1100	EMANAR REALTY L L C	127 PARSONAGE HILL RD	SHORT HILLS	NJ	07078		MARINE TOWER CONDOUNIT 1602PER CDO BK/PG: 4152/306
133	504212AH1110	EDISON,NEIL H	2500 E LAS OLAS BLVD #1603	FORT LAUDERDALE	FL	33301	1583	MARINE TOWER CONDOUNIT 1603PER CDO BK/PG: 4152/306
134	504212AH1120	WANTUCK,MICHAEL S	2500 E LAS OLAS BLVD APT 1604	FORT LAUDERDALE	FL	33301	1583	MARINE TOWER CONDOUNIT 1604PER CDO BK/PG: 4152/306
135	504212AH1130	GIUSTI,LEE-ANNE	2500 E LAS OLAS BLVD #1605	FORT LAUDERDALE	FL	33301		MARINE TOWER CONDOUNIT 1605PER CDO BK/PG: 4152/306
136	504212AH1140	DAVIS,BARBARA	2500 E LAS OLAS BLVD UNIT 1606	FORT LAUDERDALE	FL	33301	1592	MARINE TOWER CONDOUNIT 1606PER CDO BK/PG: 4152/306
137	504212AH1150	LA BAR,KATHARINE	2500 E LAS OLAS BLVD #1607	FT LAUDERDALE	FL	33301	1588	MARINE TOWER CONDOUNIT 1607PER CDO BK/PG: 4152/306
138	504212AH1160	BEAULIEU,DANIELLE	301 CH DU CLUB-MARIN #PH 4-4	*VERDUN QC	CA	H3E 1	Z2	MARINE TOWER CONDOUNIT 1608PER CDO BK/PG: 4152/306
139	504212AH1170	CHEANEY,MARY F &WEIN,JAY L	2500 E LAS OLAS BLVD #1609	FORT LAUDERDALE	FL	33301		MARINE TOWER CONDOUNIT 1609PER CDO BK/PG: 4152/306
140	504212AH1180	RAY,OREN A & BARBARA A	2500 E LAS OLAS BLVD UNIT 1701	FORT LAUDERDALE	FL	33301	1592	MARINE TOWER CONDOUNIT 1701PER CDO BK/PG: 4152/306
141	504212AH1190	HOVATER,THOMAS DKAD TR	2500 E LAS OLAS BLVD #1702	FORT LAUDERDALE	FL	33301		MARINE TOWER CONDOUNIT 1702PER CDO BK/PG: 4152/306
142	504212AH1200	DIMITRIOS S PALEOYANNIS REV TRPALEOYANNIS,DIMITRIOS TRSTE ETAL	7 ST PAUL'S CRESCENT	GARDEN CITY	NY	11530	1409	MARINE TOWER CONDOUNIT 1703PER CDO BK/PG: 4152/306
143	504212AH1210	FISHER,BRITTANY NICOLE	2500 E LAS OLAS BLVD #1704	FORT LAUDERDALE	FL	33301		MARINE TOWER CONDOUNIT 1704PER CDO BK/PG: 4152/306
144	504212AH1220	HORTON,SARA B	2500 E LAS OLAS BLVD #1705	FORT LAUDERDALE	FL	33301		MARINE TOWER CONDOUNIT 1705PER CDO BK/PG: 4152/306
145	504212AH1230	MADIA,MICHAEL R	5233 E RIVER RD	GRAND ISLAND	NY	14072		MARINE TOWER CONDOUNIT 1706PER CDO BK/PG: 4152/306
146	504212AH1240	TOPPO,SILVIASILVIA TOPPO IRREV TR	2500 E LAS OLAS BLVD #1707	FORT LAUDERDALE	FL	33301	1588	MARINE TOWER CONDOUNIT 1707PER CDO BK/PG: 4152/306
147	504212AH1250	ADAMS,JOHN BURNERDJOHN BURNERD ADAMS REV LIV TR	2500 E LAS OLAS BLVD #1708	FORT LAUDERDALE	FL	33301		MARINE TOWER CONDOUNIT 1708PER CDO BK/PG: 4152/306
148	504212AH1260	BOURHIS,MARC LUCIEN & TRACY B	2500 E LAS OLAS BLVD UNIT 1709	FORT LAUDERDALE	FL	33301	1588	MARINE TOWER CONDOUNIT 1709PER CDO BK/PG: 4152/306
149	504212AH1270	OVERMAN,KELLY CKELLY C OVERMAN REV TR	2500 E LAS OLAS BLVD APT 1801	FORT LAUDERDALE	FL	33301		MARINE TOWER CONDOUNIT 1801PER CDO BK/PG: 4152/306
150	504212AH1280	PLOUCHA,LAWRENCE & JANET	2500 E LAS OLAS BLVD #1802	FORT LAUDERDALE	FL	33301		MARINE TOWER CONDOUNIT 1802PER CDO BK/PG: 4152/306
151	504212AH1290	MAHIDA,DEVENDRA	7 SYCAMORE WAY	WARREN	NJ	07059		MARINE TOWER CONDOUNIT 1803PER CDO BK/PG: 4152/306
152	504212AH1300	TIMONE,DENIS JTIMONE,MARGARET N	384 ROUTE 100	SOMERS	NY	10589		MARINE TOWER CONDOUNIT 1804PER CDO BK/PG: 4152/306
153	504212AH1310	NAPOLITANO,TONI K	2500 E LAS OLAS BLVD APT 1805	FORT LAUDERDALE	FL	33301	1588	MARINE TOWER CONDOUNIT 1805PER CDO BK/PG: 4152/306

	A	B	C	D	E	F	G	H
154	504212AH1320	RUPPE,JAMES A	2500 E LAS OLAS BLVD APT 1808	FORT LAUDERDALE	FL	33301	1588	MARINE TOWER CONDOUNIT 1806PER CDO BK/PG: 4152/306
155	504212AH1330	ELSANADI,WAFIK	2500 E LAS OLAS BLVD #1807	FORT LAUDERDALE	FL	33301		MARINE TOWER CONDOUNIT 1807PER CDO BK/PG: 4152/306
156	504212AH1340	RUPPE,JAMES A	2500 E LAS OLAS BLVD APT 1808	FORT LAUDERDALE	FL	33301	1588	MARINE TOWER CONDOUNIT 1808PER CDO BK/PG: 4152/306
157	504212AH1350	LAS OLAS PARTNERS LLC	37 S 5 ST	PARK RIDGE	NJ	07656		MARINE TOWER CONDOUNIT 1809PER CDO BK/PG: 4152/306
158	504212AH1360	PULK,JAMES MPULK,JULIE L	2500 E LAS OLAS BLVD #1901	FORT LAUDERDALE	FL	33301		MARINE TOWER CONDOUNIT 1901PER CDO BK/PG: 4152/306
159	504212AH1370	KENGOTT,RAYMOND III & KATHLEEN E	2500 E LAS OLAS BLVD #1902	FORT LAUDERDALE	FL	33301		MARINE TOWER CONDOUNIT 1902PER CDO BK/PG: 4152/306
160	504212AH1380	BAQUERA,CONCEPCION H/EFERNANDEZ-ZULAICA,JESUS	2500 E LAS OLAS BLVD #1903	FORT LAUDERDALE	FL	33301		MARINE TOWER CONDOUNIT 1903PER CDO BK/PG: 4152/306
161	504212AH1390	DONZE,SABRINA CHRISTINE H/EDONZE,ALAN GLENN	2500 E LAS OLAS BLVD #1904	FORT LAUDERDALE	FL	33301		MARINE TOWER CONDOUNIT 1904PER CDO BK/PG: 4152/306
162	504212AH1400	ROBERTS,JONATHAN & ALISA T	114 VISTA TER S	MAHOPAC	NY	10541		MARINE TOWER CONDOUNIT 1905PER CDO BK/PG: 4152/306
163	504212AH1410	SUCCOP,JAMES W	2500 E LAS OLAS BLVD #1906	FORT LAUDERDALE	FL	33301		MARINE TOWER CONDOUNIT 1906PER CDO BK/PG: 4152/306
164	504212AH1420	TRAGER,JACQUELIN & LOUIS	2500 E LAS OLAS BLVD #1907	FORT LAUDERDALE	FL	33301		MARINE TOWER CONDOUNIT 1907PER CDO BK/PG: 4152/306
165	504212AH1430	MARINE TOWER RENTAL LLC	2856 NE 26 ST	FORT LAUDERDALE	FL	33305		MARINE TOWER CONDOUNIT 1908PER CDO BK/PG: 4152/306
166	504212AH1440	SNYDER,JOHN IJOHN I SNYDER SR LIV TR	2500 E LAS OLAS BLVD #1909	FORT LAUDERDALE	FL	33301	1588	MARINE TOWER CONDOUNIT 1909PER CDO BK/PG: 4152/306
167	504212AH1450	ROBERTS,ALISA TROBERTS,JONATHAN	114 VISTA TERRACE S	MAHOPAC	NY	10541		MARINE TOWER CONDOPH 1PER CDO BK/PG: 4152/306
168	504212AH1460	GEOFFREY,JOEL	3000 HOLIDAY DR #402	FORT LAUDERDALE	FL	33316		MARINE TOWER CONDOPH 2PER CDO BK/PG: 4152/306
169	504212AH1470	LEON,CARLOS J & DONNA S	5698 SW 103 AVE	COOPER CITY	FL	33328		MARINE TOWER CONDOPH 3PER CDO BK/PG: 4152/306
170	504212AH1480	RICHARDSON,BARBARA H/EALLENBY,JANET D	2500 E LAS OLAS BLVD #PH4	FORT LAUDERDALE	FL	33301		MARINE TOWER CONDOPH 4PER CDO BK/PG: 4152/306
171	504212AH1490	WHICKER,CATHERINE	1570 SW 115 AVE	DAVIE	FL	33325		MARINE TOWER CONDOPH 5PER CDO BK/PG: 4152/306
172	504212AH1500	MARTINGANO,FRANCIS & JOSEPHINE	159 FOREST AVE	STATEN ISLAND	NY	10301	2715	MARINE TOWER CONDOPH 6PER CDO BK/PG: 4152/306
173	504212AH1510	BARIL LIV TROUJELLET LIV TR ETAL	26 DU BOIS-DU-RUISSEAU ST RR 2	*MORIN-HEIGHTS QC	CA	J0R 1	H0	MARINE TOWER CONDOPH 7PER CDO BK/PG: 4152/306
174	504212AH1520	MCKINNON,DAVID & KAREN	2500 E LAS OLAS BLVD #PH-8	FORT LAUDERDALE	FL	33301		MARINE TOWER CONDOPH 8PER CDO BK/PG: 4152/306
175	504212AH1530	RUPPE,JAMES A	2500 E LAS OLAS BLVD APT 1808	FORT LAUDERDALE	FL	33301	1588	MARINE TOWER CONDOPH 9PER CDO BK/PG: 4152/306
176	504212BC0010	WYLIE,NATHANIELWYLIE,STACEE	3706 HARMON AVE	AUSTIN	TX	78705	1830	ESSEX TOWER CONDOUNIT 201PER CDO BK/PG: 7785/800
177	504212BC0020	BOSCARINO,LUCYLUCY BOSCARINO IRREV TR II	340 SUNSET DRIVE #203	FORT LAUDERDALE	FL	33301		ESSEX TOWER CONDOUNIT 203PER CDO BK/PG: 7785/800
178	504212BC0030	PEDERSEN,CRISTINA ELAINE JOHNSON	340 SUNSET DR #205	FORT LAUDERDALE	FL	33301		ESSEX TOWER CONDOUNIT 205PER CDO BK/PG: 7785/800
179	504212BC0040	STOUT,PATRICIA	340 SUNSET DR UNIT 207	FORT LAUDERDALE	FL	33301	2640	ESSEX TOWER CONDOUNIT 207PER CDO BK/PG: 7785/800
180	504212BC0050	PAFFORD,MECELINA C	1815 N STATE RD 7	MARGATE	FL	33063		ESSEX TOWER CONDOUNIT 209PER CDO BK/PG: 7785/800
181	504212BC0060	WILLIAMS,TERRA L	9502 WATERS LN	ROWLETT	TX	75089	4878	ESSEX TOWER CONDOUNIT 301PER CDO BK/PG: 7785/800
182	504212BC0070	ERHARD,GREGORY R	434 ELKWOOD DR	CORAOPOLIS	PA	15108	3196	ESSEX TOWER CONDOUNIT 302PER CDO BK/PG: 7785/800
183	504212BC0080	BAZAN,JOSE A GOMEZBRAITHWAITE,MARISA	6200 COCONUT TER	PLANTATION	FL	33317		ESSEX TOWER CONDOUNIT 303PER CDO BK/PG: 7785/800
184	504212BC0090	WOOLLEY,PETER W	PO BOX 611718	ROSEMARY BEACH	FL	32461		ESSEX TOWER CONDOUNIT 304PER CDO BK/PG: 7785/800

	A	B	C	D	E	F	G	H
185	504212BC0100	GALL,JUSTIN	PO BOX 72824	THORNDALE	PA	19372	0824	ESSEX TOWER CONDOUNIT 305PER CDO BK/PG: 7785/800
186	504212BC0110	SCOTTO,FRANK VSCOTTO,JENNIFER R	8 EATON CT	MARLBORO	NJ	07746		ESSEX TOWER CONDOUNIT 306PER CDO BK/PG: 7785/800
187	504212BC0120	307 HOLDINGS LLC	625 E LAS OLAS BLVD	FORT LAUDERDALE	FL	33301		ESSEX TOWER CONDOUNIT 307PER CDO BK/PG: 7785/800
188	504212BC0130	GOMEZ,JOSE A	6200 COCONUT TER	PLANTATION	FL	33317		ESSEX TOWER CONDOUNIT 308PER CDO BK/PG: 7785/800
189	504212BC0140	ACCIANI,LAWRENCE N	340 SUNSET DR UNIT 309	FORT LAUDERDALE	FL	33301	2640	ESSEX TOWER CONDOUNIT 309PER CDO BK/PG: 7785/800
190	504212BC0150	CORGNATI,JERRY	340 SUNSET DR APT 310	FORT LAUDERDALE	FL	33301	2640	ESSEX TOWER CONDOUNIT 310PER CDO BK/PG: 7785/800
191	504212BC0160	DOS SANTOS,ANTONIO R	4070 NE 16 AVE	OAKLAND PARK	FL	33334		ESSEX TOWER CONDOUNIT 311PER CDO BK/PG: 7785/800
192	504212BC0170	KERN,DALE	40 ISLE OF VENICE DR #11	FORT LAUDERDALE	FL	33301		ESSEX TOWER CONDOUNIT 401PER CDO BK/PG: 7785/800
193	504212BC0180	BIERZYNSKI,ANYA	340 SUNSET DR # 402	FORT LAUDERDALE	FL	33301		ESSEX TOWER CONDOUNIT 402PER CDO BK/PG: 7785/800
194	504212BC0190	BECKERMAN,LISA G	80 BLOOMFIELD ST #1A	HOBOKEN	NJ	07030		ESSEX TOWER CONDOUNIT 403PER CDO BK/PG: 7785/800
195	504212BC0200	PILKERTON,JEREMY	PO BOX 34	WEST CHESTER	PA	19381	0034	ESSEX TOWER CONDOUNIT 404PER CDO BK/PG: 7785/800
196	504212BC0210	BOOKSTEIN,MARK R	14661 SW 24 ST	DAVIE	FL	33325		ESSEX TOWER CONDOUNIT 405PER CDO BK/PG: 7785/800
197	504212BC0220	SULLAM,SCOTT I	340 SUNSET DR # 406	FORT LAUDERDALE	FL	33301		ESSEX TOWER CONDOUNIT 406PER CDO BK/PG: 7785/800
198	504212BC0230	MCDONALD,ANGELA TTHOMPSON,JOHN PRICE	419 CROWFIELDS DR	ASHEVILLE	NC	28803		ESSEX TOWER CONDOUNIT 407PER CDO BK/PG: 7785/800
199	504212BC0240	LAYKENHAYDEN LLC	3551 NW CLUBSIDE CIR	BOCA RATON	FL	33496		ESSEX TOWER CONDOUNIT 408PER CDO BK/PG: 7785/800
200	504212BC0250	FOSTER-CORIGLIANO TRFOSTER,JAMES J TRSTEE ETAL	3710 BAYVIEW DR	FORT LAUDERDALE	FL	33308		ESSEX TOWER CONDOUNIT 409PER CDO BK/PG: 7785/800
201	504212BC0260	CERVONI-PRIETO,CARLOS &FAFIAN,LILIANA M	340 SUNSET DR UNIT 410	FORT LAUDERDALE	FL	33301	2640	ESSEX TOWER CONDOUNIT 410PER CDO BK/PG: 7785/800
202	504212BC0270	DFGD LLC	1225 SW 87 AVE	MIAMI	FL	33174		ESSEX TOWER CONDOUNIT 411PER CDO BK/PG: 7785/800
203	504212BC0280	DONAHUE,KATHERINE PLACHTER	340 SUNSET DR #501	FORT LAUDERDALE	FL	33301	2640	ESSEX TOWER CONDOUNIT 501PER CDO BK/PG: 7785/800
204	504212BC0290	RUSSO,ROBIN SUE ANOLICK	86272 RIVERWOOD DR	YULEE	FL	32097		ESSEX TOWER CONDOUNIT 502PER CDO BK/PG: 7785/800
205	504212BC0300	PENA,ANGEL EST	340 SUNSET DR #503	FORT LAUDERDALE	FL	33301		ESSEX TOWER CONDOUNIT 503PER CDO BK/PG: 7785/800
206	504212BC0310	GEBENSLEBEN,RICK D	1822 ANDROMEDA LANE	WESTON	FL	33327		ESSEX TOWER CONDOUNIT 504PER CDO BK/PG: 7785/800
207	504212BC0320	REHA,JAMES & CLAIRE	466 LOCKHART AVE	*MONTREAL QC	CA	H3P 1	Y5	ESSEX TOWER CONDOUNIT 505PER CDO BK/PG: 7785/800
208	504212BC0330	COLLINS,CHRISTOPHER	757 SE 17 ST #846	FORT LAUDERDALE	FL	33316		ESSEX TOWER CONDOUNIT 506PER CDO BK/PG: 7785/800
209	504212BC0340	REITER,SUSAN P	340 SUNSET DR UNIT 507	FORT LAUDERDALE	FL	33301		ESSEX TOWER CONDOUNIT 507PER CDO BK/PG: 7785/800
210	504212BC0350	PETER R STARK TRSTARK,PETER R TRSTEE	408-33 DELISLE AVE	*TORONTO ON	CA	M4V 3	C7	ESSEX TOWER CONDOUNIT 508PER CDO BK/PG: 7785/800
211	504212BC0360	OLDFISH LLC	400 N ANDREWS AVE	FORT LAUDERDALE	FL	33301		ESSEX TOWER CONDOUNIT 509PER CDO BK/PG: 7785/800
212	504212BC0370	MYERS,CASEY B	1868 KAHAKAI DR APT 211	HONOLULU	HI	96814	4802	ESSEX TOWER CONDOUNIT 510PER CDO BK/PG: 7785/800
213	504212BC0380	GONZALEZ,JORGEJAECKLE,WALTER	31-10 24 AVE	ASTORIA	NY	11102	1128	ESSEX TOWER CONDOUNIT 511PER CDO BK/PG: 7785/800
214	504212BC0390	FAIRCLOUGH,JAMES RLOWE,GARY S	340 SUNSET DR APT 601	FORT LAUDERDALE	FL	33301	2671	ESSEX TOWER CONDOUNIT 601PER CDO BK/PG: 7785/800
215	504212BC0400	ORTTON,PAUL A & CAROL A	3 WARTON PL	GARDEN CITY	NY	11530		ESSEX TOWER CONDOUNIT 602PER CDO BK/PG: 7785/800

	A	B	C	D	E	F	G	H
216	504212BC0410	LECHTNER,SHIRLEY CSHIRLEY C LECHTNER REV TR	340 SUNSET DR #603	FORT LAUDERDALE	FL	33301		ESSEX TOWER CONDOUNIT 603PER CDO BK/PG: 7785/800
217	504212BC0420	DOBKINS,RICHARD	340 SUNSET DR UNIT 604	FORT LAUDERDALE	FL	33301		ESSEX TOWER CONDOUNIT 604PER CDO BK/PG: 7785/800
218	504212BC0430	POSTMA,STEVEN	212 E BROAD ST APT 3128	GREENVILLE	SC	29601	3076	ESSEX TOWER CONDOUNIT 605PER CDO BK/PG: 7785/800
219	504212BC0450	CARTER,MARY JANE	340 SUNSET DR #607	FORT LAUDERDALE	FL	33301		ESSEX TOWER CONDOUNIT 607PER CDO BK/PG: 7785/800
220	504212BC0460	ESSEX608 LLC	PO BOX 772228	MIAMI	FL	33177		ESSEX TOWER CONDOUNIT 608PER CDO BK/PG: 7785/800
221	504212BC0470	NAULT,ALLANROBERT NANCE & A NAULT REV TR	340 SUNSET DR APT 609	FORT LAUDERDALE	FL	33301	2643	ESSEX TOWER CONDOUNIT 609PER CDO BK/PG: 7785/800
222	504212BC0480	TUDOR,ILEANA MARIA	340 SUNSET DR #610	FORT LAUDERDALE	FL	33301		ESSEX TOWER CONDOUNIT 610PER CDO BK/PG: 7785/800
223	504212BC0490	ESSEX608 LLC%SING MING LIU	PO BOX 772228	MIAMI	FL	33177		ESSEX TOWER CONDOUNIT 611PER CDO BK/PG: 7785/800
224	504212BC0500	MURRAY,BELEN DBELEN D MURRAY REV TR	340 SUNSET DR #701	FORT LAUDERDALE	FL	33301		ESSEX TOWER CONDOUNIT 701PER CDO BK/PG: 7785/800
225	504212BC0510	EPSTEIN,STEVEN E & HILARY M	PO BOX 4458	FORT LAUDERDALE	FL	33338	4458	ESSEX TOWER CONDOUNIT 702PER CDO BK/PG: 7785/800
226	504212BC0520	KIMBALL,JAMES	340 SUNSET DR #709	FORT LAUDERDALE	FL	33301		ESSEX TOWER CONDOUNIT 703PER CDO BK/PG: 7785/800
227	504212BC0530	RUBIO,CHARLES ARTHURCOSTA,EDNETE COUTINHO ETAL	340 SUNSET DR #704	FORT LAUDERDALE	FL	33301		ESSEX TOWER CONDOUNIT 704PER CDO BK/PG: 7785/800
228	504212BC0540	WEBBER,KENNETH EWEBBER FAM TR	340 SUNSET DR #705	FORT LAUDERDALE	FL	33301		ESSEX TOWER CONDOUNIT 705PER CDO BK/PG: 7785/800
229	504212BC0550	NAGEL,PERRY A	340 SUNSET DR #706	FORT LAUDERDALE	FL	33301		ESSEX TOWER CONDOUNIT 706PER CDO BK/PG: 7785/800
230	504212BC0560	ASLAKSEN,ERIC C	340 SUNSET DR #707	FORT LAUDERDALE	FL	33301		ESSEX TOWER CONDOUNIT 707PER CDO BK/PG: 7785/800
231	504212BC0570	GREENHALGH,MONICA	2701 N OCEAN BLVD APT 10C	FORT LAUDERDALE	FL	33308	7541	ESSEX TOWER CONDOUNIT 708PER CDO BK/PG: 7785/800
232	504212BC0580	GOLDBERG,LEONARD H	929 SW 17 ST	FORT LAUDERDALE	FL	33315		ESSEX TOWER CONDOUNIT 709PER CDO BK/PG: 7785/800
233	504212BC0590	YUZUK,SYLVIA	340 SUNSET DR UNIT 710	FORT LAUDERDALE	FL	33301		ESSEX TOWER CONDOUNIT 710PER CDO BK/PG: 7785/800
234	504212BC0600	FREDETTE,DENYSSFICHELIS,ANTONIA	123 SYLVAN AVE	*TORONTO ON	CA	M1M 1	J6	ESSEX TOWER CONDOUNIT 711PER CDO BK/PG: 7785/800
235	504212BC0610	PORCELLI SUNSET LLC	311 RIVIERA ISLE DR	FORT LAUDERDALE	FL	33301		ESSEX TOWER CONDOUNIT 801PER CDO BK/PG: 7785/800
236	504212BC0620	HOFFMAN,RICHARD M	340 SUNSET DR #802	FORT LAUDERDALE	FL	33301	2643	ESSEX TOWER CONDOUNIT 802PER CDO BK/PG: 7785/800
237	504212BC0630	SWALES,TOM &RODGERS,CAROL	340 SUNSET DR UNIT 803	FORT LAUDERDALE	FL	33301	2643	ESSEX TOWER CONDOUNIT 803PER CDO BK/PG: 7785/800
238	504212BC0640	GOLDMAN,FEI FEI YANG	340 SUNSET DR #804	FORT LAUDERDALE	FL	33301		ESSEX TOWER CONDOUNIT 804PER CDO BK/PG: 7785/800
239	504212BC0650	PRADA,FRANCES R & OSCAR E	30 CASABLANCA ST	DANVILLE	CA	94506	4793	ESSEX TOWER CONDOUNIT 805PER CDO BK/PG: 7785/800
240	504212BC0660	SILVERMAN,BARRY P	63 E 9 ST APT 8-M	NEW YORK	NY	10003		ESSEX TOWER CONDOUNIT 806PER CDO BK/PG: 7785/800
241	504212BC0670	DANTE ORSINI REV TRORSINI,DANTE TRSTEE	195 ADAMS ST #12C	BROOKLYN	NY	11201		ESSEX TOWER CONDOUNIT 807PER CDO BK/PG: 7785/800
242	504212BC0680	ERAC INVESTMENTS INC	340 SUNSET DR #808	FORT LAUDERDALE	FL	33301		ESSEX TOWER CONDOUNIT 808PER CDO BK/PG: 7785/800
243	504212BC0690	HOFFMAN,DAVIDRUSSO,PAUL	340 SUNSET DR #809	FORT LAUDERDALE	FL	33301		ESSEX TOWER CONDOUNIT 809PER CDO BK/PG: 7785/800
244	504212BC0700	GULITE,ALAN	340 SUNSET DR #810	FORT LAUDERDALE	FL	33301		ESSEX TOWER CONDOUNIT 810PER CDO BK/PG: 7785/800
245	504212BC0710	COYNE,LORETTA Y	1519 SE 14 ST	FORT LAUDERDALE	FL	33316	2219	ESSEX TOWER CONDOUNIT 811PER CDO BK/PG: 7785/800
246	504212BC0720	BOXER,ALLENPEARL F BOXER REV INTER VIVOS TR	340 SUNSET DR #901	FORT LAUDERDALE	FL	33301		ESSEX TOWER CONDOUNIT 901PER CDO BK/PG: 7785/800

	A	B	C	D	E	F	G	H
247	504212BC0730	SIKORA,RENE E	340 SUNSET DR #902	FORT LAUDERDALE	FL	33301		ESSEX TOWER CONDOUNIT 902PER CDO BK/PG: 7785/800
248	504212BC0740	ORCHANIAN,HAGOP & NORAORCHANIAN,SILVA T & ORCHANIAN,S	10 CHURCHILL RD	WINCHESTER	MA	01890		ESSEX TOWER CONDOUNIT 903PER CDO BK/PG: 7785/800
249	504212BC0750	MARRONE,BRANDONMARRONE,RONALD	340 SUNSET DR #904	FORT LAUDERDALE	FL	33301		ESSEX TOWER CONDOUNIT 904PER CDO BK/PG: 7785/800
250	504212BC0760	RICKLES,LEE J	340 SUNSET DR #905	FORT LAUDERDALE	FL	33301		ESSEX TOWER CONDOUNIT 905PER CDO BK/PG: 7785/800
251	504212BC0770	RUBINSTEIN,HELEN	340 SUNSET DRIVE #906	FORT LAUDERDALE	FL	33301		ESSEX TOWER CONDOUNIT 906PER CDO BK/PG: 7785/800
252	504212BC0780	BREA,RAMON	340 SUNSET DR #907	FORT LAUDERDALE	FL	33301	2643	ESSEX TOWER CONDOUNIT 907PER CDO BK/PG: 7785/800
253	504212BC0790	DUNOVSKI,RISTO & VOSKRA	340 SUNSET DR #908	FORT LAUDERDALE	FL	33301		ESSEX TOWER CONDOUNIT 908PER CDO BK/PG: 7785/800
254	504212BC0800	DONNELLY,STEPHEN ASTEPHEN A DONNELLY REV LIV TR	340 SUNSET DR #909	FORT LAUDERDALE	FL	33301		ESSEX TOWER CONDOUNIT 909PER CDO BK/PG: 7785/800
255	504212BC0810	EAL HOLDINGS LLC	14362 CHESTERFIELD ROAD	ROCKVILLE	MD	20853		ESSEX TOWER CONDOUNIT 910PER CDO BK/PG: 7785/800
256	504212BC0820	MONGIELLO,JOHN MJOHN M MONGIELLO REV LIV TR	340 SUNSET DR # 911	FORT LAUDERDALE	FL	33301		ESSEX TOWER CONDOUNIT 911PER CDO BK/PG: 7785/800
257	504212BC0830	RUBINSTEIN,MICHAEL	PO BOX 244	SUGAR LOAF	NY	10981		ESSEX TOWER CONDOUNIT 1001PER CDO BK/PG: 7785/800
258	504212BC0840	VITALE,TERRY DENNIS & PATRICA A	340 SUNSET DR APT 1002	FORT LAUDERDALE	FL	33301	2646	ESSEX TOWER CONDOUNIT 1002PER CDO BK/PG: 7785/800
259	504212BC0850	PERRY,DAVID G	340 SUNSET DR APT 1003	FORT LAUDERDALE	FL	33301	2646	ESSEX TOWER CONDOUNIT 1003PER CDO BK/PG: 7785/800
260	504212BC0860	ESPOSITO,MARGARET	340 SUNSET DR # 1004	FORT LAUDERDALE	FL	33301		ESSEX TOWER CONDOUNIT 1004PER CDO BK/PG: 7785/800
261	504212BC0870	PERRY,ELIZABETH L	340 SUNSET DR #1005	FORT LAUDERDALE	FL	33301		ESSEX TOWER CONDOUNIT 1005PER CDO BK/PG: 7785/800
262	504212BC0880	OWENS,DEBORAH J	340 SUNSET DR UNIT 1006	FORT LAUDERDALE	FL	33301	2646	ESSEX TOWER CONDOUNIT 1006PER CDO BK/PG: 7785/800
263	504212BC0890	RUDD,JEFFREY C	340 SUNSET DR #1007	FORT LAUDERDALE	FL	33301		ESSEX TOWER CONDOUNIT 1007PER CDO BK/PG: 7785/800
264	504212BC0900	SACHS,LINDA S	340 SUNSET DR #1008	FORT LAUDERDALE	FL	33301		ESSEX TOWER CONDOUNIT 1008PER CDO BK/PG: 7785/800
265	504212BC0910	BLANTON,ELIZABETH	340 SUNSET DR #1009	FORT LAUDERDALE	FL	33301		ESSEX TOWER CONDOUNIT 1009PER CDO BK/PG: 7785/800
266	504212BC0920	SEDE ENTERPRISES LLC	5005 HIDALGO ST #209	HOUSTON	TX	77056		ESSEX TOWER CONDOUNIT 1010PER CDO BK/PG: 7785/800
267	504212BC0930	MUURAHAINEN,NORMA	340 SUNSET DR APT 1011	FORT LAUDERDALE	FL	33301	2646	ESSEX TOWER CONDOUNIT 1011PER CDO BK/PG: 7785/800
268	504212BC0940	O'BRIEN,STANLEY R &PAGE,LOU ANN	871 HERITAGE CT	YORKTOWN HGTS	NY	10598	1105	ESSEX TOWER CONDOUNIT 1101PER CDO BK/PG: 7785/800
269	504212BC0950	ENGLAND,NIGELENGLAND,ROCHELLE	340 SUNSET DR #1102	FORT LAUDERDALE	FL	33301		ESSEX TOWER CONDOUNIT 1102PER CDO BK/PG: 7785/800
270	504212BC0960	LEFF,MORTON JBALLARD,WILLIAM JOSEPH	340 SUNSET DR APT 1103	FORT LAUDERDALE	FL	33301	2646	ESSEX TOWER CONDOUNIT 1103PER CDO BK/PG: 7785/800
271	504212BC0970	SFICHELLI,HELENE & JEAN	1007 LOAGAN AVE	*TORONTO ON	CA	M4K 3	E6	ESSEX TOWER CONDOUNIT 1104PER CDO BK/PG: 7785/800
272	504212BC0980	MICHAEL V EVANGELISTI REV TREVANGELISTI,MICHAEL V TRSTEE	349 IDLEWYLD DR	FORT LAUDERDALE	FL	33301		ESSEX TOWER CONDOUNIT 1105PER CDO BK/PG: 7785/800
273	504212BC0990	JOLLY,MARK G	340 SUNSET DR #1106	FORT LAUDERDALE	FL	33301		ESSEX TOWER CONDOUNIT 1106PER CDO BK/PG: 7785/800
274	504212BC1000	CABRALOFF,LISA GRIGORIAN	340 SUNSET DR #1107	FORT LAUDERDALE	FL	33301		ESSEX TOWER CONDOUNIT 1107PER CDO BK/PG: 7785/800
275	504212BC1010	STROM,JANET M	671 LAKESIDE CIR #606	POMPANO BEACH	FL	33060		ESSEX TOWER CONDOUNIT 1108PER CDO BK/PG: 7785/800
276	504212BC1020	LACROIX,LAWRENCE & JANELACROIX REV TR	340 SUNSET DR #1109	FORT LAUDERDALE	FL	33301		ESSEX TOWER CONDOUNIT 1109PER CDO BK/PG: 7785/800
277	504212BC1030	CATHERINE L LYONS LIV TRDEBRA J DEJESUS LIV TR ETAL	65 WATERFORD DR	HANOVER	MA	02339		ESSEX TOWER CONDOUNIT 1110PER CDO BK/PG: 7785/800

	A	B	C	D	E	F	G	H
278	504212BC1040	BROE,HARLEYKNOTT,NANCY J	4163 BEACH DR SW APT 101	SEATTLE	WA	98116	3590	ESSEX TOWER CONDOUNIT 1111PER CDO BK/PG: 7785/800
279	504212BC1050	GARGANI,ADAM	267 CARLETON AVE STE 202	CENTRAL ISLIP	NY	11722	4544	ESSEX TOWER CONDOUNIT 1201PER CDO BK/PG: 7785/800
280	504212BC1060	PIROZZI,PETER V H/ECAMPIONE,PAULA J	340 SUNSET DR # 1202	FORT LAUDERDALE	FL	33301		ESSEX TOWER CONDOUNIT 1202PER CDO BK/PG: 7785/800
281	504212BC1070	GORMAN,MARK EDWARDMENDOZA,MIGUEL ANGEL	1804 CORAL RIDGE DR	FORT LAUDERDALE	FL	33305		ESSEX TOWER CONDOUNIT 1203PER CDO BK/PG: 7785/800
282	504212BC1080	CONCEICAO,IVAN L	340 SUNSET DR APT 1204	FORT LAUDERDALE	FL	33301	2646	ESSEX TOWER CONDOUNIT 1204PER CDO BK/PG: 7785/800
283	504212BC1090	COBBS,TOMAS	340 SUNSET DR #1205	FORT LAUDERDALE	FL	33301		ESSEX TOWER CONDOUNIT 1205PER CDO BK/PG: 7785/800
284	504212BC1100	WEIGER,DIANA L	340 SUNSET DR #1206	FORT LAUDERDALE	FL	33301	2646	ESSEX TOWER CONDOUNIT 1206PER CDO BK/PG: 7785/800
285	504212BC1110	BROSNAHAN,JAMES E	340 SUNSET DR. #1207	FORT LAUDERDALE	FL	33301		ESSEX TOWER CONDOUNIT 1207PER CDO BK/PG: 7785/800
286	504212BC1120	DEROSA,DANISE H/EDEROSA,NICHOLAS	340 SUNSET DR UNIT 1208	FORT LAUDERDALE	FL	33301	2646	ESSEX TOWER CONDOUNIT 1208PER CDO BK/PG: 7785/800
287	504212BC1130	FORD,MARK & SHELLE	340 SUNSET DR #1209	FORT LAUDERDALE	FL	33301		ESSEX TOWER CONDOUNIT 1209PER CDO BK/PG: 7785/800
288	504212BC1140	ABTAN,BERNARD H/EEL AMIRI,ZINEB	340 SUNSET DR #1210	FORT LAUDERDALE	FL	33301		ESSEX TOWER CONDOUNIT 1210PER CDO BK/PG: 7785/800
289	504212BC1150	WEINROD,MARK BAWTREY,WARREN	301 N BIRCH RD APT 7S	FORT LAUDERDALE	FL	33304	4289	ESSEX TOWER CONDOUNIT 1211PER CDO BK/PG: 7785/800
290	504212BC1160	OLIVER,JAMES A & WUNDER,DONALD M	PO BOX 843	OGUNQUIT	ME	03907		ESSEX TOWER CONDOUNIT 1401PER CDO BK/PG: 7785/800
291	504212BC1170	STANLEY L SCOTT REV TRANGELA E SCOTT SUCC TTEE	22603 CAMINO DEL MAR APT 1319	BOCA RATON	FL	33433	6522	ESSEX TOWER CONDOUNIT 1402PER CDO BK/PG: 7785/800
292	504212BC1180	D'AMBROSIO,MARIA G	340 SUNSET DR #1403	FORT LAUDERDALE	FL	33301		ESSEX TOWER CONDOUNIT 1403PER CDO BK/PG: 7785/800
293	504212BC1190	BAILEY,STEPHEN R	301 N PALM CANYON DR STE 103	PALM SPRINGS	CA	92262	5672	ESSEX TOWER CONDOUNIT 1404PER CDO BK/PG: 7785/800
294	504212BC1200	DREWNIOK,HEIKEWHEBLE,GREGORY BRIAN	340 SUNSET DR #1405	FORT LAUDERDALE	FL	33301		ESSEX TOWER CONDOUNIT 1405PER CDO BK/PG: 7785/800
295	504212BC1210	SPIVACK,CYNTHIA J	340 SUNSET DR #1406	FORT LAUDERDALE	FL	33301	2653	ESSEX TOWER CONDOUNIT 1406PER CDO BK/PG: 7785/800
296	504212BC1220	TOZZI,GINO V	340 SUNSET DR #1407	FORT LAUDERDALE	FL	33301		ESSEX TOWER CONDOUNIT 1407PER CDO BK/PG: 7785/800
297	504212BC1230	AXER,MANFRED H	615 BAYSHORE DR APT 301	FORT LAUDERDALE	FL	33304	3935	ESSEX TOWER CONDOUNIT 1408PER CDO BK/PG: 7785/800
298	504212BC1240	COSENTINO,GIUSEPPE	340 SUNSET DR #409	FORT LAUDERDALE	FL	33301		ESSEX TOWER CONDOUNIT 1409PER CDO BK/PG: 7785/800
299	504212BC1250	CLOUGH,LISA E	340 SUNSET DR #1410	FORT LAUDERDALE	FL	33301		ESSEX TOWER CONDOUNIT 1410PER CDO BK/PG: 7785/800
300	504212BC1260	HARNICK,MARTIN ROBERTMARTIN R HARNICK REV LIV TR	340 SUNSET DR #1411	FORT LAUDERDALE	FL	33301	2649	ESSEX TOWER CONDOUNIT 1411PER CDO BK/PG: 7785/800
301	504212BC1270	MORRISON,JOHN A JRDOBB,ROBERT K JR	8 WELLINGTON PL	REHOBOTH BEACH	DE	19971		ESSEX TOWER CONDOUNIT 1501PER CDO BK/PG: 7785/800
302	504212BC1280	BONOMI,VITTORIO	340 SUNSET DR #1502	FORT LAUDERDALE	FL	33301		ESSEX TOWER CONDOUNIT 1502PER CDO BK/PG: 7785/800
303	504212BC1290	KIRSTEN SMITH RUSH REV LIV TRRUSH,KIRSTEN & FRANCIS	15 FORT ROYAL ISLE	FORT LAUDERDALE	FL	33306		ESSEX TOWER CONDOUNIT 1503PER CDO BK/PG: 7785/800
304	504212BC1300	LOMBARDO,CATHARINE B MCGUIRE	VIA NAVARINO 5A	*LIDO VENEZIA	IL	30126		ESSEX TOWER CONDOUNIT 1504PER CDO BK/PG: 7785/800
305	504212BC1320	JUNAID,SHARON	524 ISABEL DR	MARTINEZ	CA	94553		ESSEX TOWER CONDOUNIT 1506PER CDO BK/PG: 7785/800
306	504212BC1330	SHALAPIN,MARY M	18 MORGAN LAKE DR	MILLSTADT	IL	62260		ESSEX TOWER CONDOUNIT 1507PER CDO BK/PG: 7785/800
307	504212BC1340	GRAZIANI,NORMAN	340 SUNSET DR #1508	FORT LAUDERDALE	FL	33301		ESSEX TOWER CONDOUNIT 1508PER CDO BK/PG: 7785/800
308	504212BC1350	LUKE REV TR	340 SUNSET DR #1509	FORT LAUDERDALE	FL	33301		ESSEX TOWER CONDOUNIT 1509PER CDO BK/PG: 7785/800

	A	B	C	D	E	F	G	H
309	504212BC1360	DALTON,KEVIN & LESLIE	340 SUNSET DR APT 1510	FORT LAUDERDALE	FL	33301	2649	ESSEX TOWER CONDOUNIT 1510PER CDO BK/PG: 7785/800
310	504212BC1370	HIPPEE,MICHAEL EMICHAEL E HIPPEE 2010 LIV TR	340 SUNSET DR # 1511	FORT LAUDERDALE	FL	33301		ESSEX TOWER CONDOUNIT 1511PER CDO BK/PG: 7785/800
311	504212BC1380	CHRISTOPHER ROBERT REV TRRYAN MITCHELL PRICE REV TR ETAL	340 SUNSET DR #1601	FORT LAUDERDALE	FL	33301		ESSEX TOWER CONDOUNIT 1601PER CDO BK/PG: 7785/800
312	504212BC1390	WILPAN,EDWARDEDWARD WILPAN REV TR	340 SUNSET DR #1602	FORT LAUDERDALE	FL	33301		ESSEX TOWER CONDOUNIT 1602PER CDO BK/PG: 7785/800
313	504212BC1400	SCHULTZ,DONNA L	340 SUNSET DR #1603	FORT LAUDERDALE	FL	33301	2649	ESSEX TOWER CONDOUNIT 1603PER CDO BK/PG: 7785/800
314	504212BC1410	NORRELL,ELIZABETH C	340 SUNSET DR #1604	FORT LAUDERDALE	FL	33301		ESSEX TOWER CONDOUNIT 1604PER CDO BK/PG: 7785/800
315	504212BC1420	MORMANDO,FRANK	340 SUNSET DR UNIT 1605	FORT LAUDERDALE	FL	33301	2649	ESSEX TOWER CONDOUNIT 1605PER CDO BK/PG: 7785/800
316	504212BC1430	STRAITS,LLOYD ALLOYD & RUTH STRAITS TR	340 SUNSET DR #1606	FORT LAUDERDALE	FL	33301		ESSEX TOWER CONDOUNIT 1606PER CDO BK/PG: 7785/800
317	504212BC1440	ROBERT MAHAR REV TRMAHAR,ROBERT TRSTEE	316 S 2 ST #A	PHILADELPHIA	PA	19106	4342	ESSEX TOWER CONDOUNIT 1607PER CDO BK/PG: 7785/800
318	504212BC1450	ARLENE TATARKA- HAIDAR REV TRHAIDAR,ARLENE TATARKA TRSTEE	6515 NE 20 AVE	FORT LAUDERDALE	FL	33308	1013	ESSEX TOWER CONDOUNIT 1608PER CDO BK/PG: 7785/800
319	504212BC1460	MIGNOLET,JEAN EJEAN E MIGNOLET REV TR	340 SUNSET DR APT 1609	FORT LAUDERDALE	FL	33301	2649	ESSEX TOWER CONDOUNIT 1609PER CDO BK/PG: 7785/800
320	504212BC1470	MEIER,JUDITH C	340 SUNSET DR #1610	FORT LAUDERDALE	FL	33301	2649	ESSEX TOWER CONDOUNIT 1610PER CDO BK/PG: 7785/800
321	504212BC1480	FULTON,ELLEN ELIZABETHSTEIN FULTON,WENDY JILL	340 SUNSET DR #1611	FORT LAUDERDALE	FL	33301		ESSEX TOWER CONDOUNIT 1611PER CDO BK/PG: 7785/800
322	504212BC1490	DIEKMAN,HERMAN	340 SUNSET DR #1701	FORT LAUDERDALE	FL	33301		ESSEX TOWER CONDOUNIT 1701PER CDO BK/PG: 7785/800
323	504212BC1500	FISHER,RICKEY VICTORCARRIERE-FISHER,LYNNE	84 DE BRIGNOLES	*GATINEAU QC	CA	J8T 8	E3	ESSEX TOWER CONDOUNIT 1702PER CDO BK/PG: 7785/800
324	504212BC1510	SEILER,NINON	340 SUNSET DR UNIT 1703	FORT LAUDERDALE	FL	33301	2649	ESSEX TOWER CONDOUNIT 1703PER CDO BK/PG: 7785/800
325	504212BC1520	FULTON,WENDY J STEINFULTON,ELLEN E	340 SUNSET DR #1611	FORT LAUDERDALE	FL	33301		ESSEX TOWER CONDOUNIT 1704PER CDO BK/PG: 7785/800
326	504212BC1530	HOFFMAN,BARBARA A	340 SUNSET DR #1705	FORT LAUDERDALE	FL	33301	2649	ESSEX TOWER CONDOUNIT 1705PER CDO BK/PG: 7785/800
327	504212BC1540	DA PONT,GEORGEKAO,IVAN C Y	2403-200 RIDEAU ST	*OTTAWA ON	CA	K1N 5	Y1	ESSEX TOWER CONDOUNIT 1706PER CDO BK/PG: 7785/800
328	504212BC1550	BURKE,AARON J	4761 NE 4 AVE	OAKLAND PARK	FL	33334	6038	ESSEX TOWER CONDOUNIT 1707PER CDO BK/PG: 7785/800
329	504212BC1560	ADAMS,DAVIDCERMINARO,RUSSELL	340 SUNSET DR #1708	FORT LAUDERDALE	FL	33301		ESSEX TOWER CONDOUNIT 1708PER CDO BK/PG: 7785/800
330	504212BC1570	BAVLITSCHKO,DAVID ADAVID A BAVLITSCHKO REV TR	340 SUNSET DR APT 1709	FORT LAUDERDALE	FL	33301	2649	ESSEX TOWER CONDOUNIT 1709PER CDO BK/PG: 7785/800
331	504212BC1580	SIMONETTI,LEONILDE	340 SUNSET DR #1710	FORT LAUDERDALE	FL	33301		ESSEX TOWER CONDOUNIT 1710PER CDO BK/PG: 7785/800
332	504212BC1590	GIANNETTI,IRENEHENAFF,CHRISTIAN	146 JASPER AVE	*TOWN OF MOUNT-ROYAL Q	CA	H3P 1	J9	ESSEX TOWER CONDOUNIT 1711PER CDO BK/PG: 7785/800
333	504212BC1600	RANSING,LAURA	757 SE 17 ST # 912	FORT LAUDERDALE	FL	33316	2960	ESSEX TOWER CONDOUNIT 1801PER CDO BK/PG: 7785/800
334	504212BC1610	HAGA,YOSHIE	9705 DECREE LN	VIENNA	VA	22181	3256	ESSEX TOWER CONDOUNIT 1802PER CDO BK/PG: 7785/800
335	504212BC1620	HUDEC,DANIEL J	340 SUNSET DR UNIT 1803	FORT LAUDERDALE	FL	33301	2649	ESSEX TOWER CONDOUNIT 1803PER CDO BK/PG: 7785/800
336	504212BC1630	GANDOLFO,CHRISTOPHERGANDOLFO,LISA	2803 CRYSTAL CT	MIAMI	FL	33133		ESSEX TOWER CONDOUNIT 1804PER CDO BK/PG: 7785/800
337	504212BC1640	FRYE,GEORGE D	340 SUNSET DR APT 1805	FORT LAUDERDALE	FL	33301	2649	ESSEX TOWER CONDOUNIT 1805PER CDO BK/PG: 7785/800
338	504212BC1650	MANLEY,JAMES E JR	19 FOREST RD #21	WALLKILL	NY	12589		ESSEX TOWER CONDOUNIT 1806PER CDO BK/PG: 7785/800
339	504212BC1660	CROUSE,NATALINACROUSE,RICHARD JOSEPH	PO BOX 3763	SYRACUSE	NY	13220		ESSEX TOWER CONDOUNIT 1807PER CDO BK/PG: 7785/800

	A	B	C	D	E	F	G	H
340	504212BC1670	GOEHRIG,CARMEN & LAWRENCE JR	340 SUNSET DR #1808	FORT LAUDERDALE	FL	33301		ESSEX TOWER CONDOUNIT 1808PER CDO BK/PG: 7785/800
341	504212BC1680	OLKOVICH,KRYSTYNA	340 SUNSET DR #1809	FORT LAUDERDALE	FL	33301		ESSEX TOWER CONDOUNIT 1809PER CDO BK/PG: 7785/800
342	504212BC1690	NORVELL, ANITA NOELLEANITA NOELLE NORVELL REV LIV TR	340 SUNSET DR #1810	FORT LAUDERDALE	FL	33301	2654	ESSEX TOWER CONDOUNIT 1810PER CDO BK/PG: 7785/800
343	504212BC1700	CHEIKEN,HOWARDSMITS,DANIEL	340 SUNSET DR #1811	FORT LAUDERDALE	FL	33301		ESSEX TOWER CONDOUNIT 1811PER CDO BK/PG: 7785/800

# OLIVE | JUDD

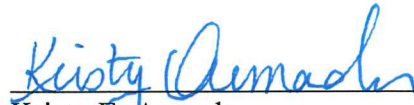

Kristy E. Armada

Dated: February 5, 2021

Proposed Renovation Re: 2426 EAST LAS OLAS LLC  
Request for Variance  
2426 East Las Olas Boulevard

## **Introduction**

The Applicant, 2426 East Las Olas LLC, is proposing to construct a renovation to its existing office located at 2426 East Las Olas Boulevard. Specifically, Applicant is seeking to expand its conference room, located in the northwest section of the building by moving the northern exterior wall north a distance of 2.25 feet.

The Applicant acquired the property in 2013. At the time, the property's finished floor elevation was below the required City of Fort Lauderdale Code requirements and as a result was experiencing regular flooding from various weather events and the King Tides. Applicant renovated the property and focused its renovations on significantly raising the elevation to comply with the City of Fort Lauderdale's Municipal Code. In so doing, at great expense to the Applicant, the Property was protected from the susceptibility of recurrent flooding. Thus, the Applicant's property, as well as the property of its neighbors, was better safeguarded from the frequent flooding in the area. At the time of this renovation, the entire north wall of the building was located on the north property line. In addition to raising the elevation, the Applicant moved the wall of the northwest section 5 feet south of the property line and constructed a planter along this façade with the northern planter wall being located on the north property line. By adding the planter, the Applicant has realized that the size of its northwest conference room is unusable. As such, Applicant is requesting that it be permitted to move the northwest window wall north a distance of 2.75 feet to a distance that is 2.25 feet from the property line. The north planter wall will not be moved, and the planter will remain a viable planter for greenspace.

## **Application/Request**

The Applicant is seeking the following relief from ULDR Sec . 47-6.20, set back requirements of the CB-Community Business zoning district:

Setback	Required	Proposed	Variance Request
Front (Las Olas)	5'	2.25'	2.75'

The Applicant has encountered several unique hardships attributable to the land and existing building, and therefore, the above referenced variance is being requested. The Applicant submits that the criteria to granting variances established by ULDR Section 47-24.12.A.4 are satisfied as demonstrated below:

**a. That special conditions and circumstances affect the property at issue which prevent the reasonable use of such property.**

The entire north building wall was located on the property line at the time the applicant purchased the Property. Upon information and belief, the building was constructed prior to the imposition of the five-foot setback by the Zoning Code. The north walls of all other buildings within this block are similarly located on the north property line. The Applicant moved the northwest window wall five feet from the property line in order to install the planter losing approximately 103 SF of usable space. The relocated façade wall resulted in a significant decrease of building square footage and an irregularly shaped conference room, the size of which does not permit the comfortable use thereof. There is no need for a five-foot wide planter in this location. A planter width of 2.25 feet can accommodate the same type of plant material that is currently in place. The requested variance would increase the Property by a total of only 57 square feet. The enforcement of the five-foot setback is a special condition and circumstance as it relates only to the Applicant. The Applicant is the only property owner on the 2400 block of Las Olas Boulevard affected by its enforcement. Please see a photo of 2400 block building façades all uniformly situated on the north property line.





- b. That the circumstances which cause the special conditions are peculiar to the property at issue, or to such a small number of properties that they clearly constitute marked exceptions to other properties in the same zoning district.**

The special conditions and circumstances are peculiar to this Property and constitute a marked exception to other neighboring properties in the CB zoning district. This property, when acquired, was susceptible to frequent flooding events. To remedy the hazards associated with the flooding, Applicant raised the elevation of the Building and added a planter to the building. Moving the

northwest wall five feet back from the property line from its original position resulted in a reduction of the building's square footage and producing an irregularly shaped conference room, the size of which does not permit the comfortable use thereof.

- c. That the literal application of the provisions of the ULDR would deprive the applicant of a substantial property right that is enjoyed by other property owners in the same zoning district. It shall be of no importance to this criterion that a denial of the variance sought might deny to the owner a more profitable use of the property, provided the provisions of the ULDR still allow a reasonable use of the property.**

The main reason for the front setback requirement, although not expressly stated in the ULDR, is to establish uniform development patterns along roadways. All of the neighboring buildings sit on the property line. Enforcing the setback requirement against the Applicant's property would create a disparity between the other buildings in the block and the Applicant's building.

Literal application of the provision of the ULDR would deprive Applicant from improving the Property which is a right enjoyed by other property owners on this block. Consideration should be given that, historically, the building's northwest wall was on the property line, the north planter wall is on the property line and will remain on the property line. The width of the sidewalk, and the public's enjoyment of same, will not be affected.

- d. That the unique hardship is not self-created by the applicant or his predecessors, nor is it the result of mere disregard for, or ignorance of, the provisions of the ULDR or antecedent zoning regulations.**

The hardship was created by the fact that the building was initially constructed in 1955, prior to the adoption of the City's ULDR. At the time the building was constructed, there apparently was no set back requirement for this building. The Applicant did not construct the initial building and given the locations of the buildings situated on the 2400 block of Las Olas Boulevard and the setback requirement as it applies only to the Applicant, this hardship is unique to the Applicant.

- e. That the variance is the minimum variance that will make possible a reasonable use of the property and that the variance will be in harmony with the general purposes and intent of the ULDR and the use as varied will not be incompatible with adjoining properties or the surrounding neighborhood or otherwise detrimental to the public welfare.**

The requested variance is the minimum variance necessary to make a reasonable use of the improvements. The Applicant is seeking to move the northwest window wall 2.75 feet into the set back. The general purpose and intent of the ULDR is to promote the health, safety, morals, comfort, prosperity, and general welfare of the community. Although not expressly stated in the ULDR, the general purpose of the front setback is to establish uniform development patterns along the roadways. The requested variance will not disrupt the uniform development pattern along Las Olas as all surrounding buildings are constructed on the property line. Furthermore, the existing planter wall will not be moved and the nature and quality of the planter and landscaping will remain. The request will have little to no impact on the public or the neighboring properties. All

of the building owners in the 2400 block have no objection to the requested variance. The variance will be in harmony with the general purpose and intent of the ULDR. The requested variance will not be incompatible with adjoining properties or the surrounding neighborhood or otherwise detrimental to the public welfare. as all surrounding buildings are constructed on the property line. If granted, this variance will be in harmony with the general purpose of the ULDR. Please see a photo of the Applicant's existing façade:



This request is also compatible with the adjoining properties. A letter of support written by Idlewood Place, LLC, the owner of the property to the west of the Applicant is attached hereto.

SE 23RD AVE

E LAS OLAS BLVD

PLZ LAS OLAS

SUNSET DR

SE 26TH AVE RIVIERA ISLE DR

RIVIERA DR

ISLE

POINCIANA DR

SE 26TH AVE

RD LEWYLD DR





2426

OLIVE | JUDD

IG SALON

OLIVE | JUDD

34

2





MERRIMAC  
VENTURES

MOTPL S COM  
95-45 0450  
VM 177

SOLAR 177

OLIVE | JUDD



GRANDIOSE  
REAL ESTATE

2400-

GRANDIOSE  
Adam  
Licensed Real  
954.63



  
**GRANDIOSE**  
REAL ESTATE

2400-A





February 4, 2021

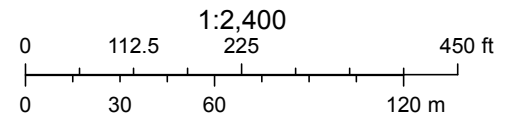

# Aerial 2

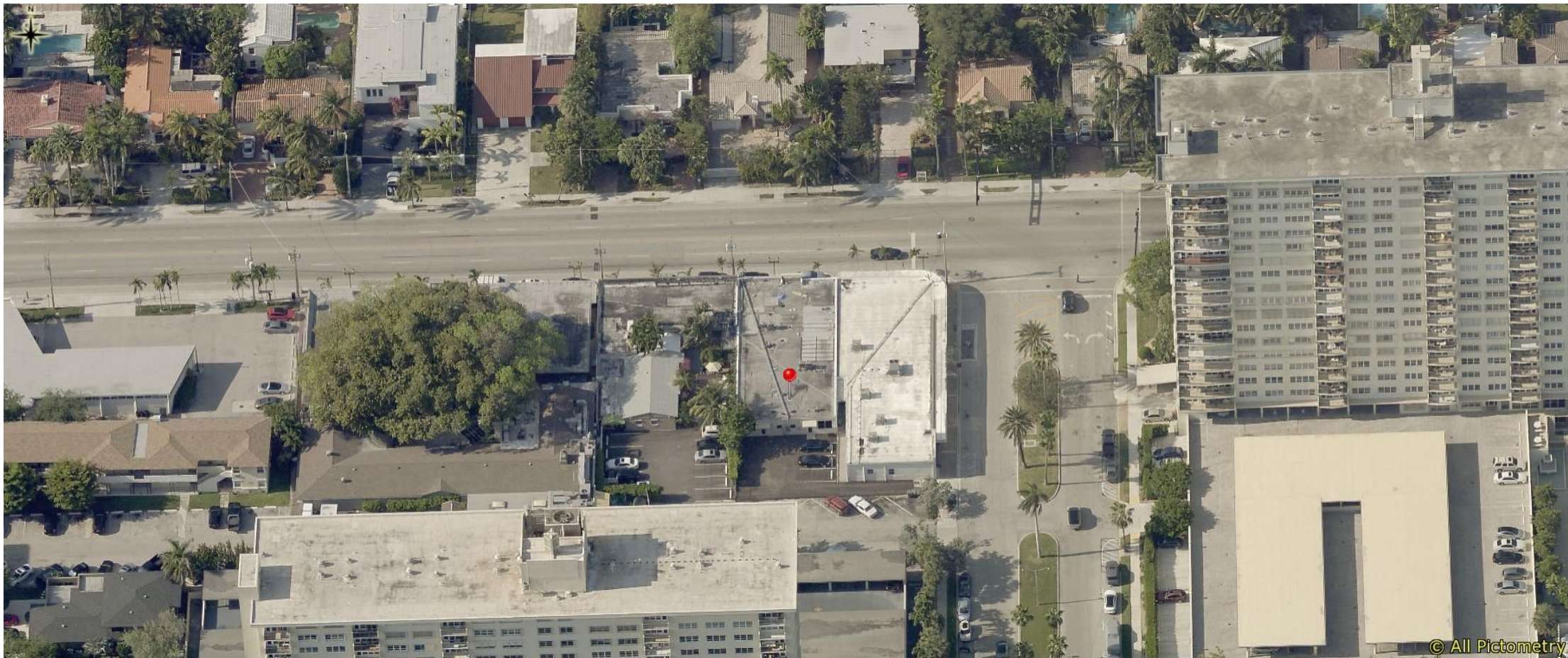

© All Pictometry



# PINNELL SURVEY, INC.

5300 W. HILLSBORO BLVD., SUITE 215-A COCONUT CREEK, FLORIDA 33073  
PHONE(954)418-4940 FAX(954)418-4941 EMAIL: order@sfland.net  
CERTIFICATE NO.: LB6857

**SURVEY ADDRESS:**

2426 EAST LAS OLAS BOULEVARD  
FORT LAUDERDALE, FLORIDA 33301

**CERTIFY TO:**

1. 2426 EAST LAS OLAS, LLC
2. HACKLEMAN, OLIVE & JUDD, P.A.
3. OLD REPUBLIC NATIONAL TITLE INSURANCE COMPANY
4. FIRST REPUBLIC BANK, ITS SUCCESSORS AND/OR ASSIGNS, AS THEIR INTEREST MAY APPEAR

**FLOOD ZONE & ELEVATIONS:**

FLOOD ZONE: AE  
BASE FLOOD ELEVATION: 5'  
CONTROL PANEL NO.: 125105-0576-H  
DATE OF FIRM INDEX: 08/18/14

**POTENTIAL ENCROACHMENTS:**

1. 4 FOOT C.L.F. AND ASPHALT PAVEMENT CROSS OVER THE WESTERLY PROPERTY LINE.
2. ASPHALT PAVEMNT CROSSES OVER THE EASTERLY PROPERTY LINE.

**LEGAL DESCRIPTION:**

THE WEST TWENTY (20) FEET OF LOT ONE (1) AND THE EAST THIRTY (30) FEET OF LOT 2, OF A RESUBDIVISION OF BLOCKS 13 AND 14, AND PART OF BLOCK A OF IDLEWYLD, ACCORDING TO THE PLAT THEREOF, AS RECORDED IN PLAT BOOK 7, AT PAGE 38, OF THE PUBLIC RECORDS OF BROWARD COUNTY, FLORIDA.

**LEGEND & ABBREVIATIONS:**

A	= ARC	D.E.	= DRAINAGE EASEMENT	P.C.	= POINT OF CURVATURE
A/C	= AIR CONDITIONER	ELEV.	= ELEVATION	P.E.	= POOL EQUIPMENT
A.E.	= ANCHOR EASEMENT	E.S.	= ELECTRIC SERVICE	P.I.	= POINT OF INTERSECTION
B.M.	= BENCHMARK	F.P. & L.	= FLORIDA POWER & LIGHT	P.R.C.	= POINT OF REVERSE CURVE
B.C.R.	= BROWARD COUNTY RECORDS	L.B.	= LICENSED BUSINESS	P.O.B.	= POINT OF BEGINNING
C.B.S.	= CONCRETE BLOCK STRUCTURE	L.P.	= LIGHT POLE	P.O.C.	= POINT OF COMMENCEMENT
CHATT.	= CHATTAHOOCHEE	M.H.	= MANHOLE	P.P.	= POWER POLE
C.O.	= CLEANOUT	(M)	= MEASURED	R	= RADIUS
CONC.	= CONCRETE	NAVD	= NORTH AMERICAN VERTICAL DATUM	R/W	= RIGHT-OF-WAY
C.L.F.	= CHAIN LINK FENCE	NGVD	= NATIONAL GEODETIC VERTICAL DATUM	T	= TANGENT
C.L.P.	= CONCRETE LIGHT POLE	NO.	= NUMBER	(TYP.)	= TYPICAL
(C)	= CALCULATED	O.H.	= OVERHANG	U.E.	= UTILITY EASEMENT
C.B.	= CHORD BEARING	O.R.B.	= OFFICIAL RECORDS BOOK	W.F.	= WOOD FENCE
C.R.	= CABLE RISER	O/S	= OFFSET	W.M.	= WATER METER
(D)	= DEED	(P)	= PLAT	Δ	= DELTA OR CENTRAL ANGLE
D.B.	= DEED BOOK	P.B.C.R.	= PALM BEACH COUNTY RECORDS	⊕	= CENTERLINE
M-D.C.R.	= MIAMI-DADE COUNTY RECORDS	P.B.	= PLAT BOOK	$\frac{82}{82}$	= ELEVATION

**GENERAL NOTES:**

1. TYPE OF SURVEY: BOUNDARY
2. IF THIS SURVEY HAS BEEN REVISED AS INDICATED IN THE REVISION BOX SHOWN HEREON, THEN ANY AND ALL PREVIOUS VERSIONS OF THIS SURVEY PREPARED BY PINNELL SURVEY, INC. ARE NULL & VOID.
3. THE PROPERTY SHOWN HEREON WAS NOT ABSTRACTED FOR OWNERSHIP, RIGHTS-OF-WAY, EASEMENTS OR OTHER MATTERS OF RECORD BY PINNELL SURVEY, INC. THERE MAY BE ADDITIONAL RESTRICTIONS THAT ARE NOT DEPICTED ON THIS SURVEY THAT MAY BE FOUND IN THE PUBLIC RECORDS OF THE COUNTY, FOR WHICH THE SUBJECT PROPERTY IS LOCATED IN.
4. UNLESS OTHERWISE NOTED, FIELD MEASUREMENTS ARE IN AGREEMENT WITH RECORD MEASUREMENTS.
5. ELEVATIONS SHOWN HEREON (IF ANY) ARE RELATIVE TO NAVD 1988, UNLESS OTHERWISE NOTED.
6. UNDERGROUND IMPROVEMENTS AND UTILITIES ARE NOT LOCATED.
7. FENCE AND WALL OWNERSHIP IS NOT DETERMINED.
8. THIS DRAWING IS THE PROPERTY OF PINNELL SURVEY, INC. AND SHALL NOT BE USED OR REPRODUCED, WHOLE OR IN PART WITHOUT WRITTEN PERMISSION & AUTHORIZATION FROM PINNELL SURVEY, INC.
9. ALL EASEMENTS SHOWN ON THE ATTACHED DRAWING ARE PER THE RECORD PLAT (UNLESS OTHERWISE NOTED).
10. THIS SURVEY IS FOR MORTGAGE AND TITLE PURPOSES ONLY.

**CERTIFICATION:**

THIS IS TO CERTIFY THAT I HAVE RECENTLY SURVEYED THE PROPERTY DESCRIBED IN THE FOREGOING TITLE CAPTION AND HAVE SET OR FOUND MONUMENTS AS INDICATED ON THIS SKETCH AND THAT SAID ABOVE GROUND SURVEY AND SKETCH ARE ACCURATE AND CORRECT TO THE BEST OF MY KNOWLEDGE AND BELIEF. I FURTHER CERTIFY THAT THIS SURVEY MEETS THE STANDARDS OF PRACTICE UNDER RULE 5J-17, FLORIDA ADMINISTRATIVE CODE, ADOPTED BY THE FLORIDA STATE BOARD OF PROFESSIONAL SURVEYORS AND MAPPERS. THIS SURVEY IS NOT VALID WITHOUT THE ORIGINAL SIGNATURE AND SEAL OF A FLORIDA LICENSED SURVEYOR AND MAPPER, UNLESS IT IS ELECTRONICALLY SIGNED AND SEALED.

JASON H. PINNELL  
PROFESSIONAL SURVEYOR & MAPPER  
LICENSE NO. 5734, STATE OF FLORIDA

REVISIONS	DATE	CHK'D BY

<b>SKETCH NO.:</b> 20-1070
<b>DATE OF SURVEY:</b> 06/16/20
<b>CHECKED BY:</b> O.C.
<b>FIELD BOOK/PAGE:</b> FILE
<b>SIDE 1 OF 2</b>



# EAST LAS OLAS BOULEVARD

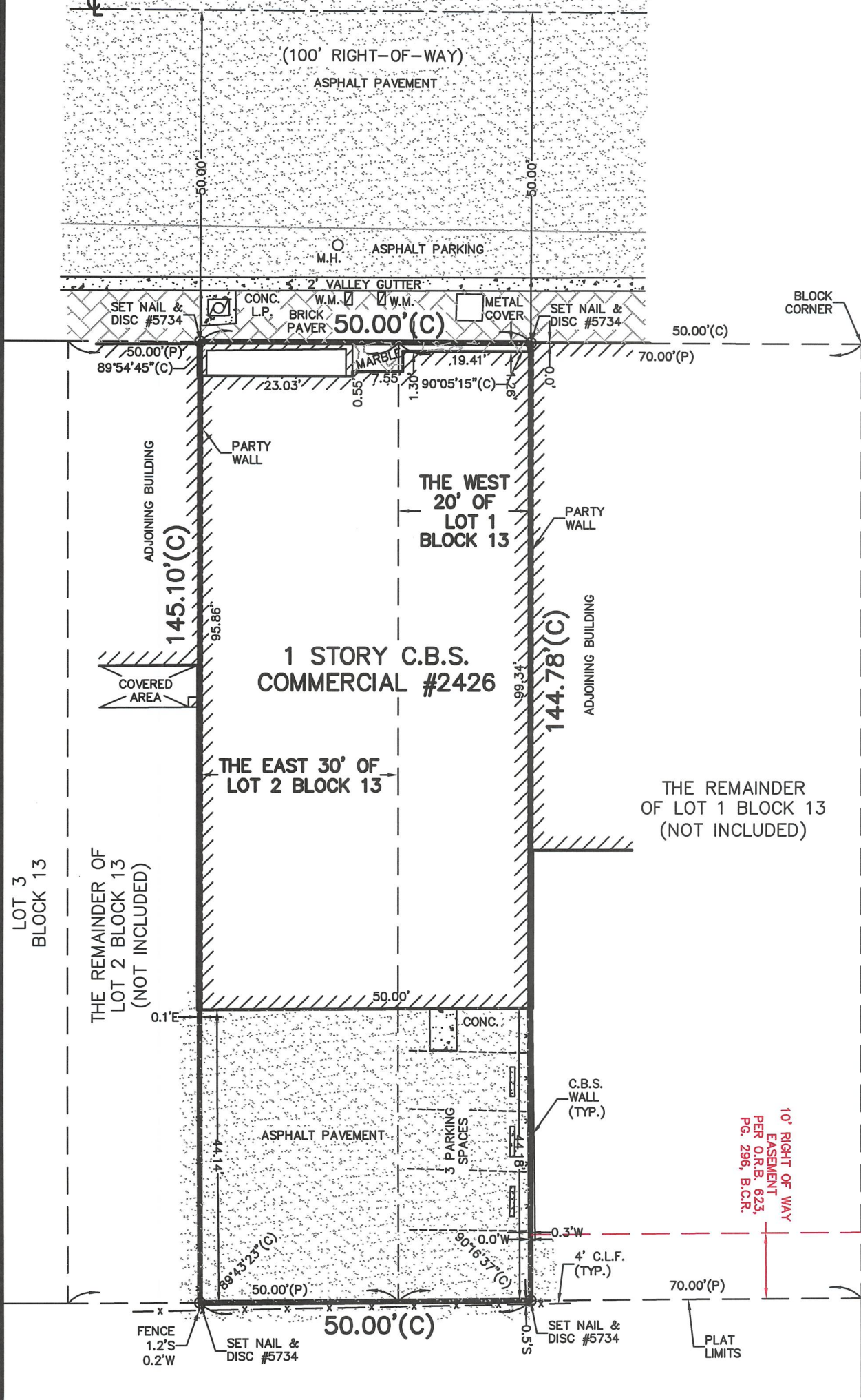

RIVIERA  
(P.B. 6, PG. 17, B.C.R.)

10' RIGHT OF WAY  
EASEMENT  
PER O.R.B. 623,  
PG. 296, B.C.R.

SCALE: 1" = 20'	SKETCH NO.: 20-1070
DRAWN BY: K.V.	SIDE 2 OF 2

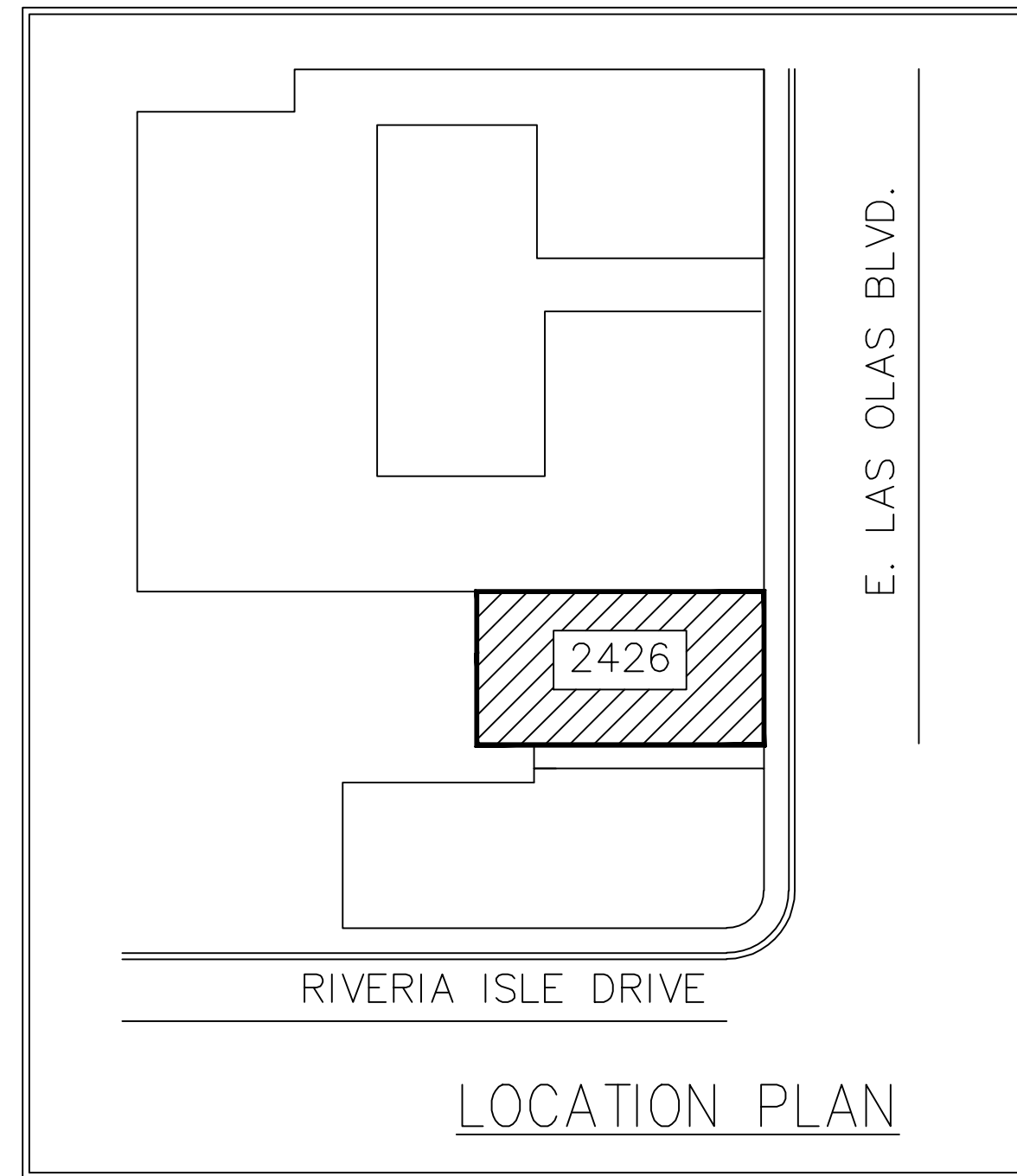

BUILDING OCCUPANCY	
EXISTING OCCUPANCY—GROUP B BUSINESS	
TYPE V CONSTRUCTION – NON SPRINKLED	
EFFECTIVE CODE	
2017 FLORIDA BUILDING CODE RESIDENTIAL, 6TH EDITION	
ASCE-7-14	
SCOPE OF WORK:	
EXPAND EXISTING CONFERENCE ROOM BY 57 S.F. BY	
PULLING EXISTING EXTERIOR WALL TO THE NORTH	
LEVEL 2 ALTERATION	
PERSCRIPTIVE COMPLIANCE METHOD	
ZONED CB	

AREA CALCULATIONS	
EXISTING OFFICE	4,750 S.F.
NEW CONFERENCE ROOM EXPANSION	57 S.F.
TOTAL UNDER ROOF	4,807 S.F.
OCCUPANT LOAD	
FOR BUSINESS AREAS:	
4,807 S.F. / 100 S.F. PER PERSON= 49 PEOPLE	
(INCLUDES CONFERENCE ROOM EXPANSION)	
PLUMBING FIXTURE COUNT	
GROUP B BUSINESS	
W.C.= 1 PER 25 FOR THE FIRST 50- 2 REQUIRED	4 EXISTING
LAV- 1 PER 40 FOR THE FIRST 80- 2 REQUIRED	4 EXISTING
DRINKING FOUNTAIN- 1 PER 100- 1 EXISTING	4 EXISTING
F.E.- 10# ABC FIRE EXTINGUISHER, WALL MOUNTED	

DRAWING INDEX	
D-1 DEMOLITION PLAN	
A-1 FLOOR PLAN/ELEVATION	
A-2 ELECTRICAL/ MECHANICAL	
A-3 WALL SECTIONS	

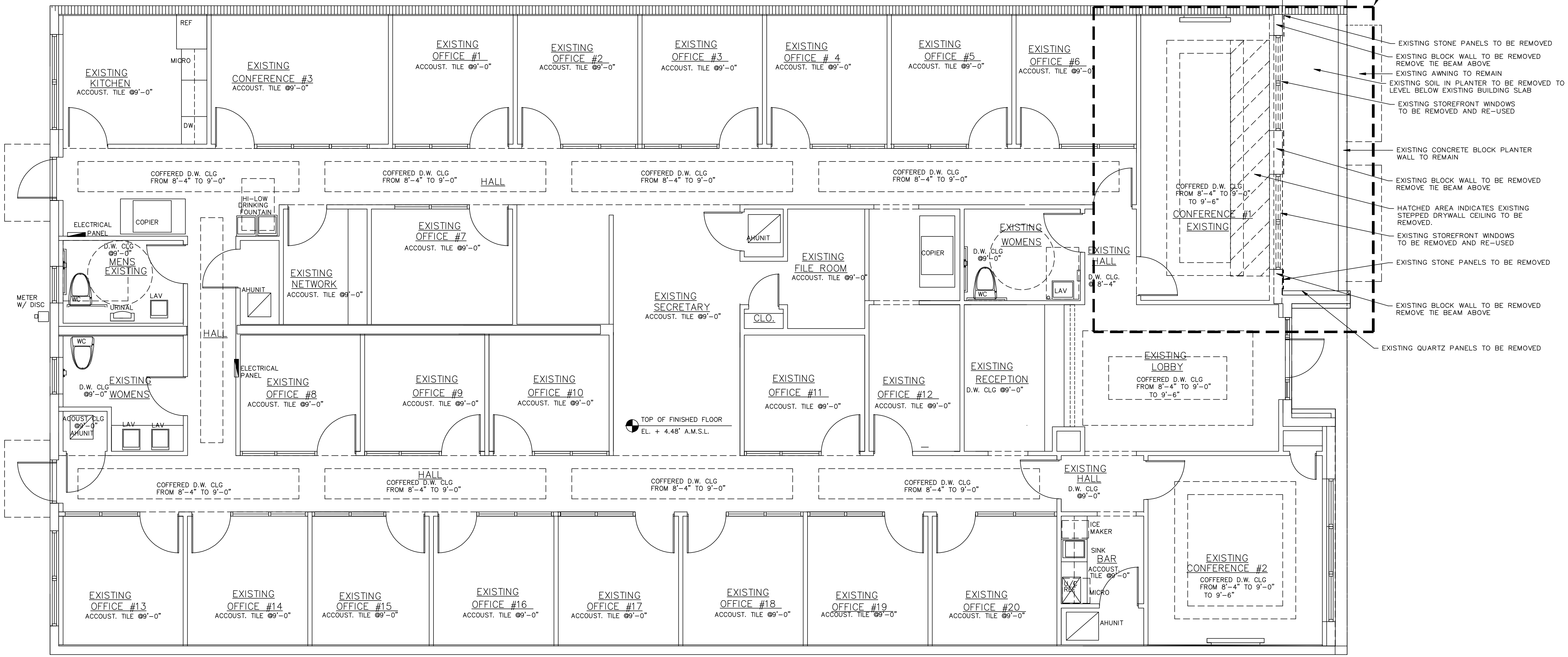

DEMOLITION FLOOR PLAN  
SCALE: 1/4"=1'-0"  
N

SEAL

REVISIONS  
9-29-2020 permit set

GERALD BELORAVE DESIGNS, LLC  
Architect - Planner - Interior Designer  
4823 N.W. 66th AVE. LAUDERHILL, FLORIDA 33319  
Phone (954) 298-2540  
Arch. Reg. No. 15,085

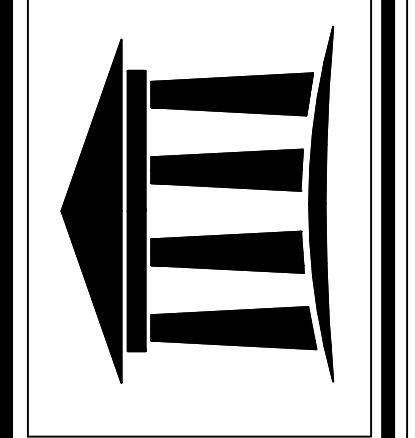

CONFERENCE ROOM EXPANSION AT:  
2426 E. LAS OLAS BLVD.  
FORT LAUDERDALE, FLORIDA

Job No: 2K045  
Date: 8-19-2020  
Drawn by: JEB  
Checked: CB

ARCHITECTURE  
Drawing No.  
**D-1**

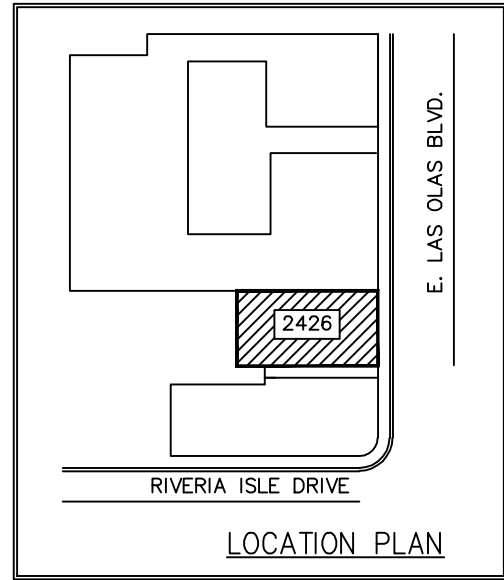

<b>BUILDING OCCUPANCY</b>
EXISTING OCCUPANCY—GROUP B BUSINESS
TYPE V CONSTRUCTION — NON SPRINKLED
EFFECTIVE CODE
2017 FLORIDA BUILDING CODE RESIDENTIAL, 6TH EDITION
ASCE-7-14
<b>SCOPE OF WORK:</b>
EXPAND EXISTING CONFERENCE ROOM BY 57 S.F. BY
PULLING EXISTING EXTERIOR WALL TO THE NORTH
<b>LEVEL 2 ALTERATION</b>
PERSCRPTIVE COMPLIANCE METHOD
ZONED CB

<b>AREA CALCULATIONS</b>
EXISTING OFFICE 4,750 S.F.
NEW CONFERENCE ROOM EXPANSION 57 S.F.
<b>TOTAL UNDER ROOF 4,807 S.F.</b>
<b>OCCUPANT LOAD FOR BUSINESS AREAS:</b>
4,807 S.F. / 100 S.F. PER PERSON = 49 PEOPLE
(INCLUDES CONFERENCE ROOM EXPANSION)
<b>PLUMBING FIXTURE COUNT</b>
GROUP B BUSINESS
W.C.— 1 PER 25 FOR THE FIRST 50— 2 REQUIRED 4 EXISTING
LAV— 1 PER 40 FOR THE FIRST 80— 2 REQUIRED 4 EXISTING
DRINKING FOUNTAIN— 1 PER 100— 1 EXISTING
F.E.— 10# ABC FIRE EXTINGUISHER, WALL MOUNTED

<b>DRAWING INDEX</b>
D-1 DEMOLITION PLAN
A-1 FLOOR PLAN/ELEVATION
A-2 ELECTRICAL/ MECHANICAL
A-3 WALL SECTIONS

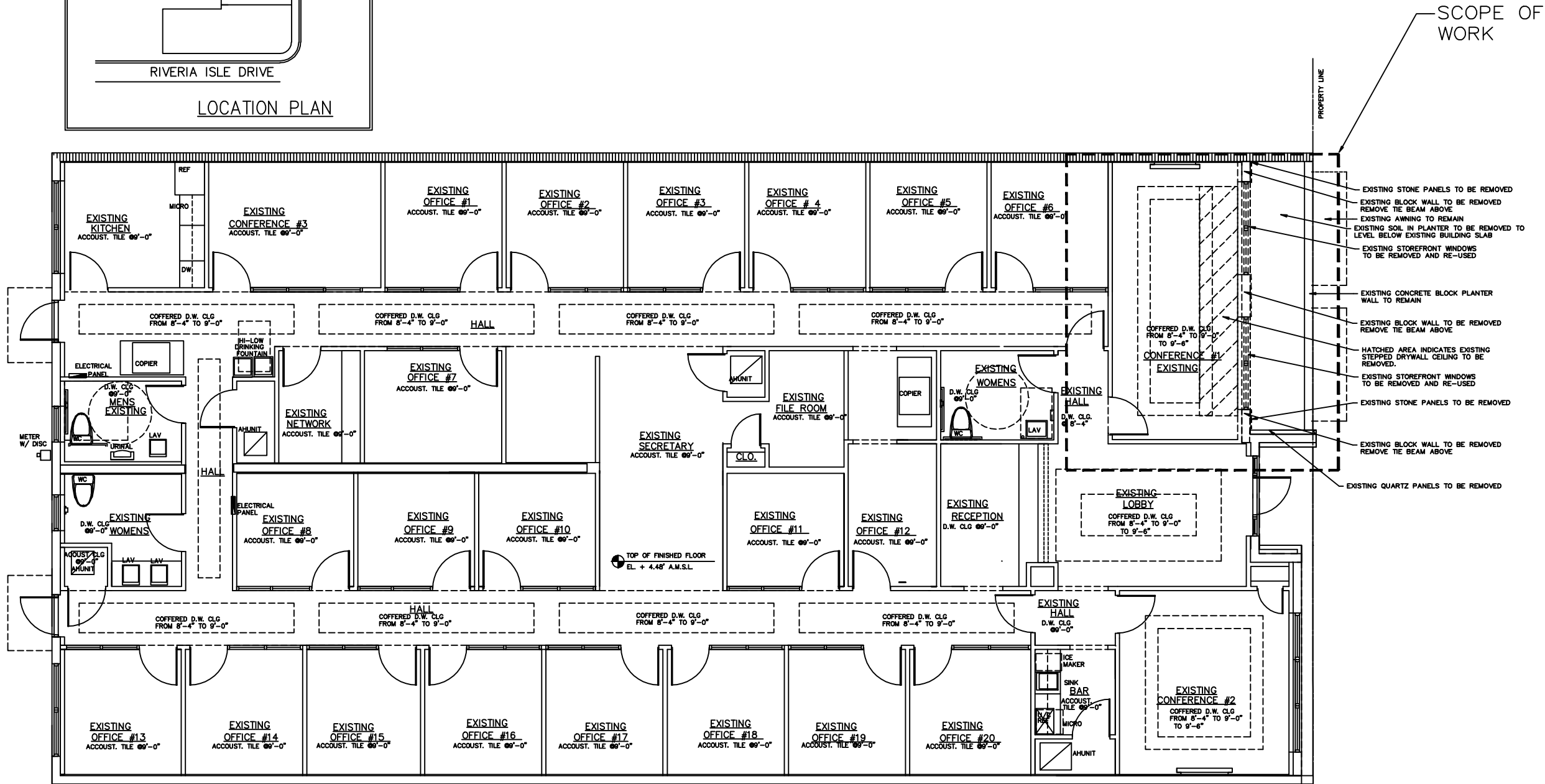

DEMOLITION FLOOR PLAN  
SCALE: 1/4"=1'-0"

SEAL

REVISIONS

9-29-2020 permit set

GERALD BELGRAVE DESIGNS, LLC  
Architect - Planner - Interior Designer  
4823 N.W. 66th AVE. LAUDERHILL, FLORIDA 33319  
Phone (954) 298-2540  
Arch. Reg. No. 15,085

CONFERENCE ROOM EXPANSION AT  
2426 E. LAS OLAS BLVD.  
FORT LAUDERDALE, FLORIDA

Arch. No. 21045  
Date: 8-19-2020  
Drawn by: JJB  
Checked by: GIB

ARCHITECTURE  
Drawing No.  
**D-1**

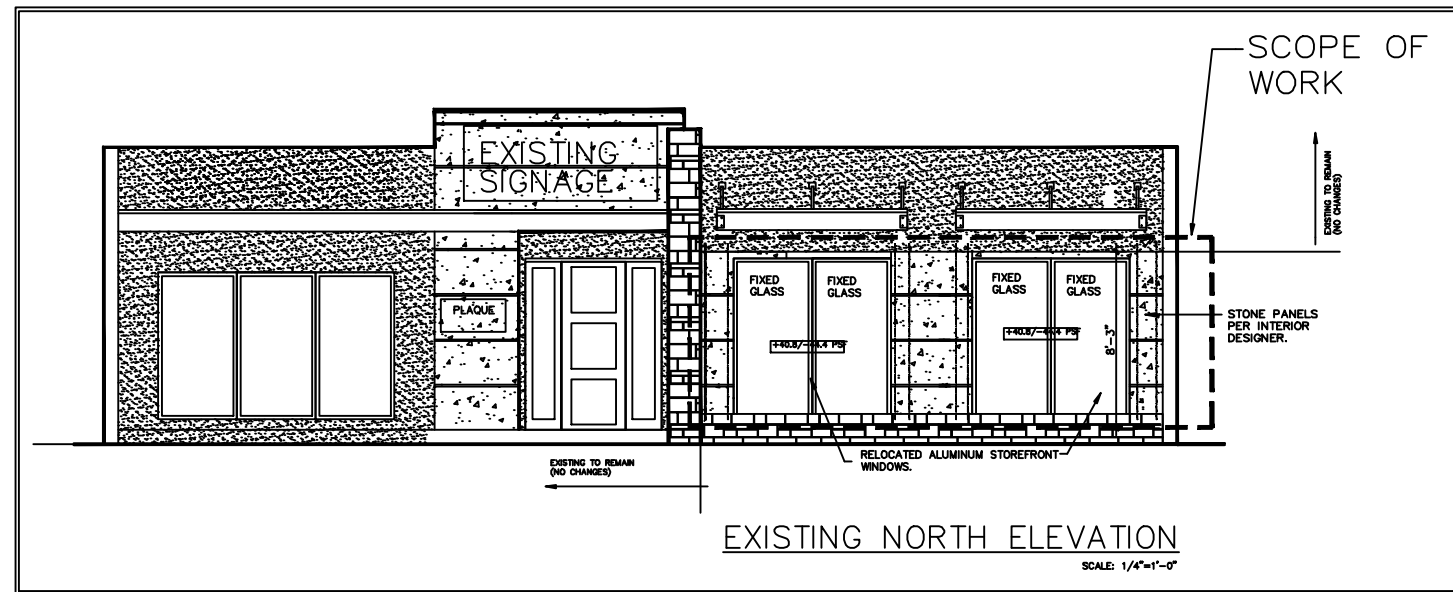

**WALL SYMBOL LEGEND**

	EXISTING CONCRETE BLOCK WALL .WHERE NEW CONSTRUCTION MEETS EXISTING PROVIDE NEW 5/8" DRYWALL OVER 1X3 P.T. WOOD FURRING @ 24" O.C. W/ R-4.1 INSULATION BETWEEN. DRYWALL IN RESTROOMS AND KITCHEN. PAINT PER INTERIOR DESIGNER.
	EXISTING DRYWALL PARTITION. WHERE NEW CONSTRUCTION MEETS EXISTING, PATCH TO MATCH. PAINT PER INTERIOR DESIGNER.
	NEW 8" CONCRETE BLOCK WALL. FINISH EXTERIOR SIDE WITH STONE PANELS TO MATCH. FINISH INTERIOR SIDE WITH 5/8" DRYWALL OVER 3-5/8" METAL STUDS @ 16" O.C. WITH R-11 BATT INSULATION BETWEEN. PAINT PER DESIGNER.

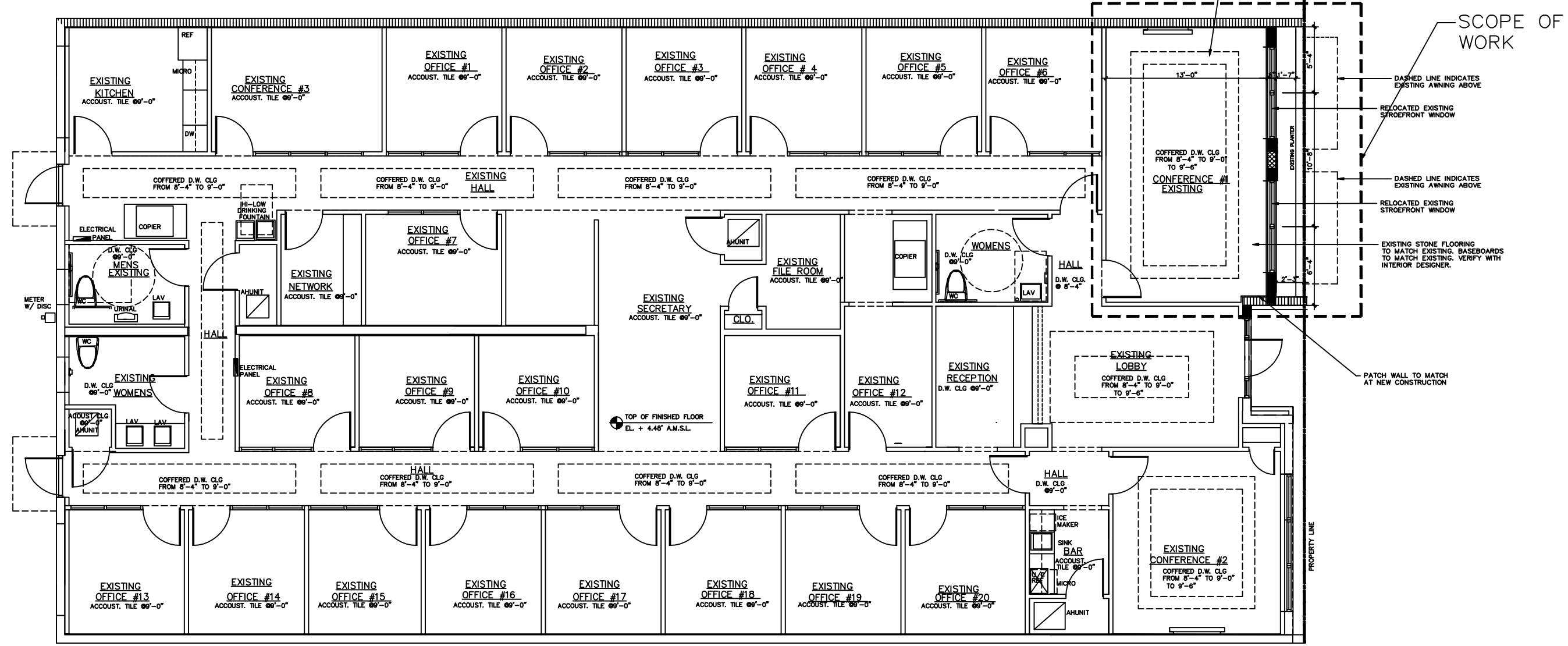

**FLOOR PLAN**  
SCALE: 1/4"=1'-0"  
N

SEAL

REVISIONS

9-28-2020	permit set
-----------	------------

GERALD BELGRAVE DESIGNS, LLC  
Architect - Planner - Interior Designer  
4823 N.W. 68th AVE. LAUDERHILL, FLORIDA 33319  
Phone (954) 298-2540  
Arch. Reg. No. 15,085

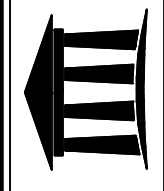

**CONFERENCE ROOM EXPANSION AT:**  
**2496 E. LAS OLAS BLVD.**  
**FORT LAUDERDALE, FLORIDA**

Job No:	21045
Date:	8-19-2020
Drawn by:	JB
Checked by:	GB

ARCHITECTURE  
Drawing No.  
**A-1**

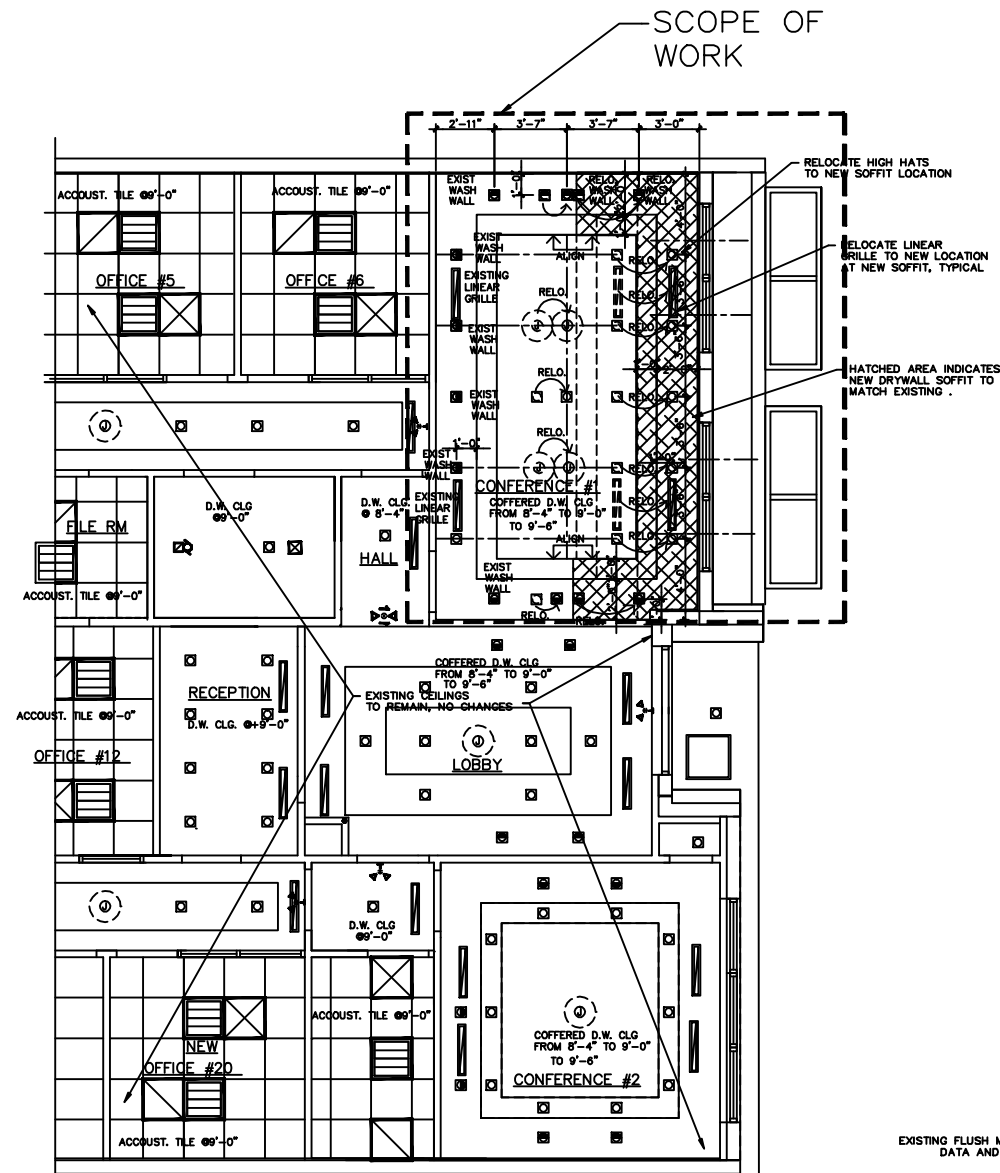

REFLECTED CEILING PLAN  
SCALE: 1/4"=1'-0"

**REFLECTED CEILING NOTES**  
FOR ALL DRYWALL CEILINGS, USE 1-5/8" 22 GA. METAL STUDS @ 16" O.C., FINISH WITH 5/8" DRYWALL.

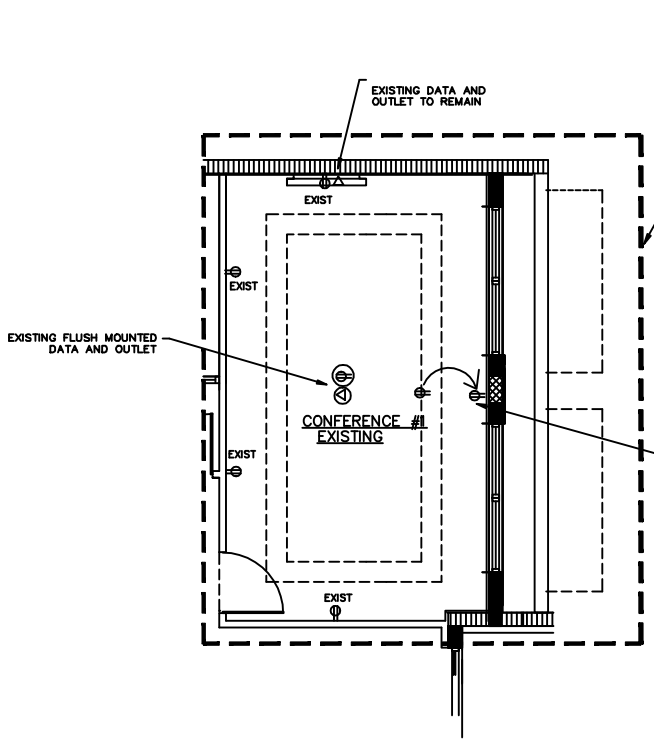
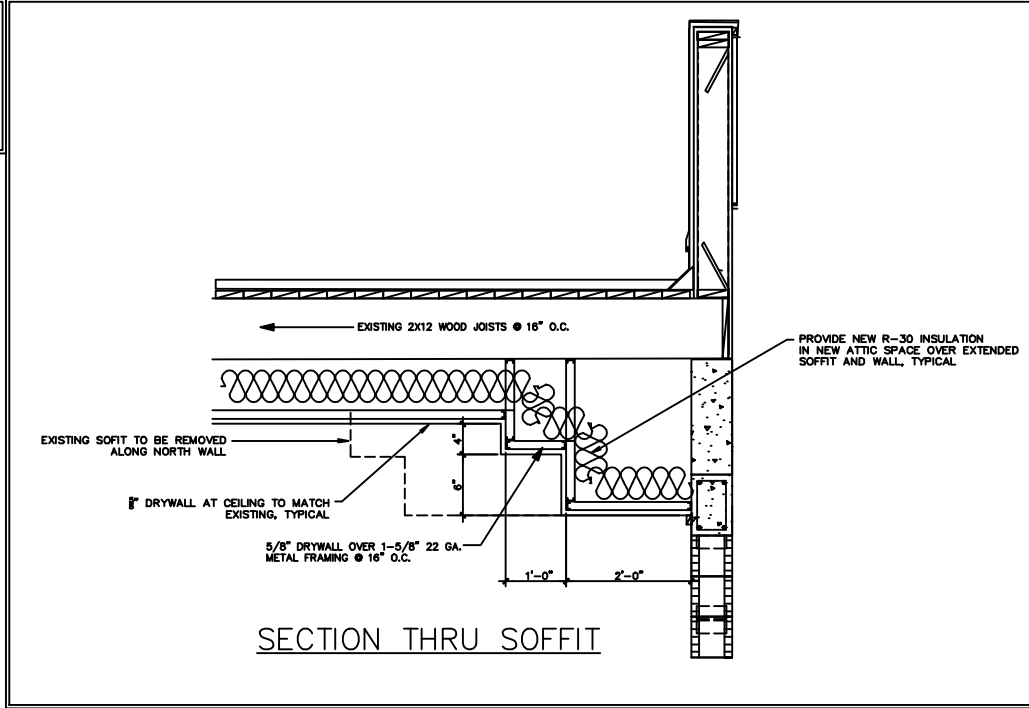
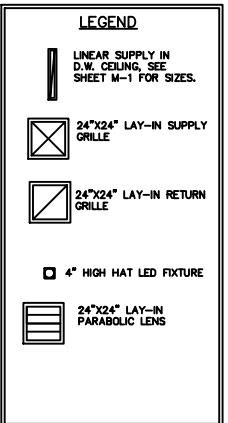

PARTIAL ELECTRICAL FLOOR PLAN  
SCALE: 1/4"=1'-0"

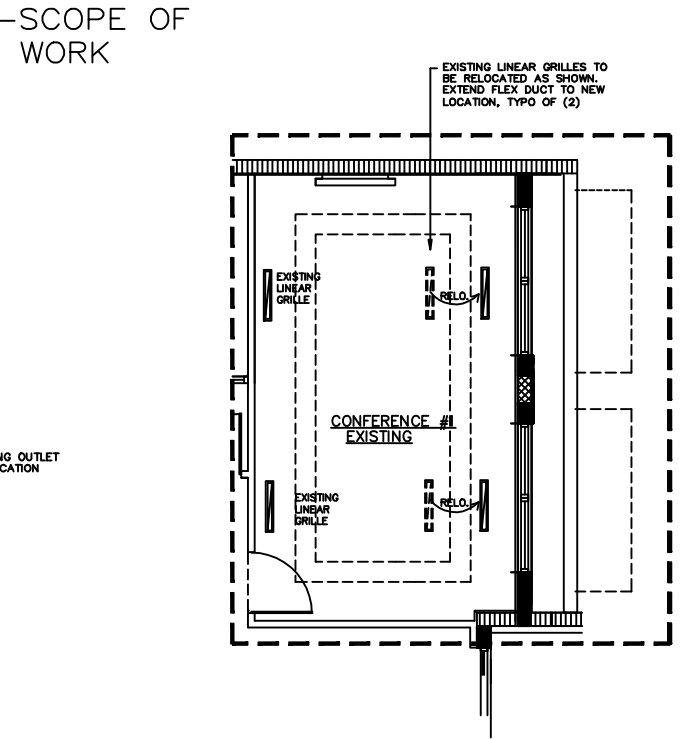

PARTIAL MECHANICAL FLOOR PLAN  
SCALE: 1/4"=1'-0"

SEAL

REVISIONS

	9-29-2020 permit set
--	----------------------

GERALD BELGRAVE DESIGNS, LLC  
Architect - Planner - Interior Designer  
4823 N.W. 66th AVE. LAUDERHILL, FLORIDA 33319  
Phone (954) 298-2540  
Arch. Reg. No. 15,085

**CONFERENCE ROOM EXPANSION AT  
2426 E. LAS OLAS BLVD.  
FORT LAUDERDALE, FLORIDA**

Sht. No. 20276	Date 8-19-2020	Drawn by JB	Checked by GB
ARCHITECTURE			
Drawing No.			
<b>A-2</b>			

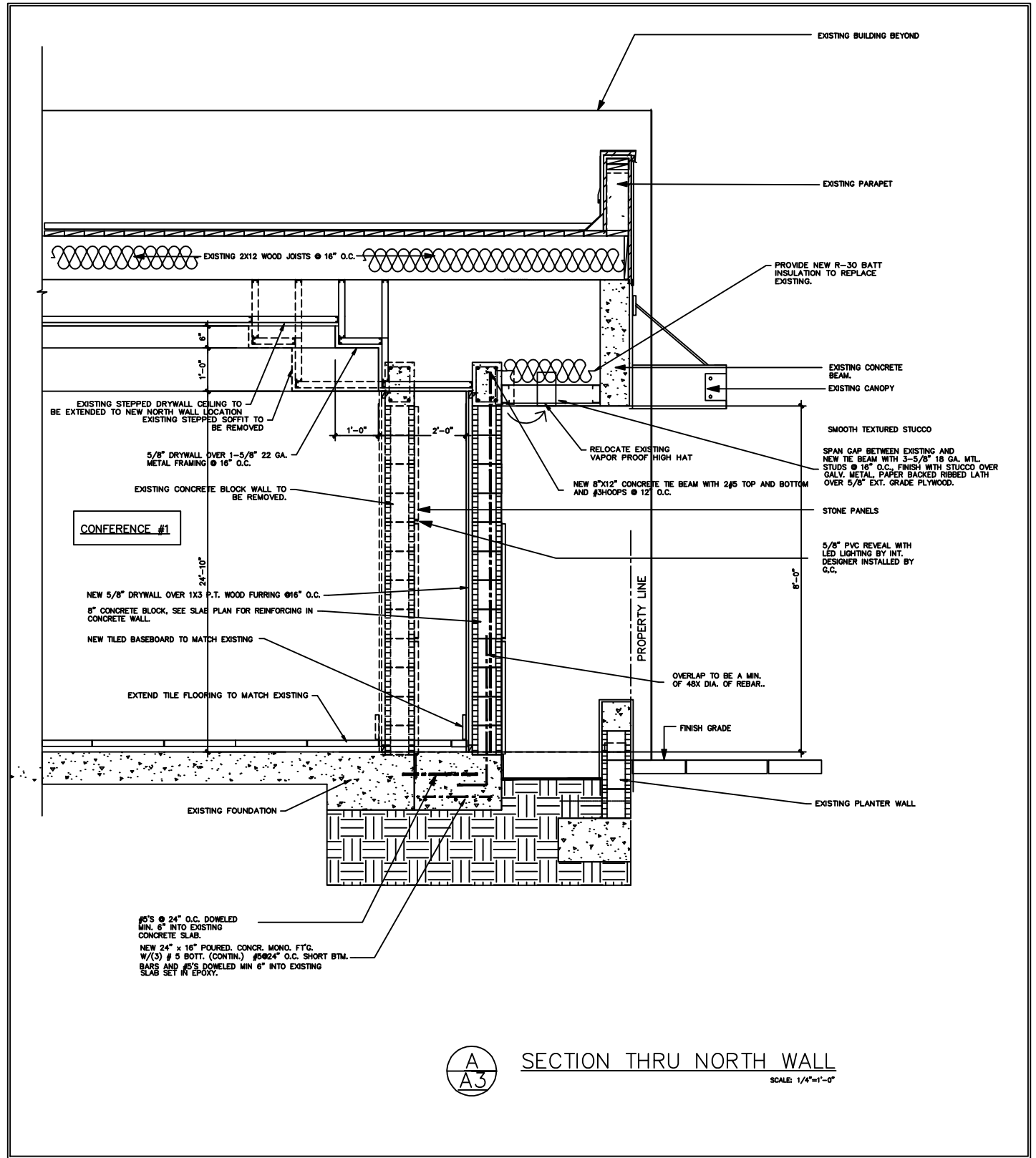

**A**  
**A3** SECTION THRU NORTH WALL  
SCALE: 1/4"=1'-0"

**DESIGN CRITERIA:**  
 - REF.: FLORIDA BUILDING CODE 2017 ED.  
 - ASCE 7-10  
 - 170 MPH WIND VELOCITY  
 - IMPORTANCE FACTOR OF 1.0  
 - COEFFICIENT OF INTERNAL PRESSURE OF 0.18  
 - EXPOSURE "C"  
 - BUILDING CATEGORY II  
 - ROOF STRUCTURE DESIGNED BASED ON COMPONENTS & CLADDING  
 - Kd FACTOR =1.0

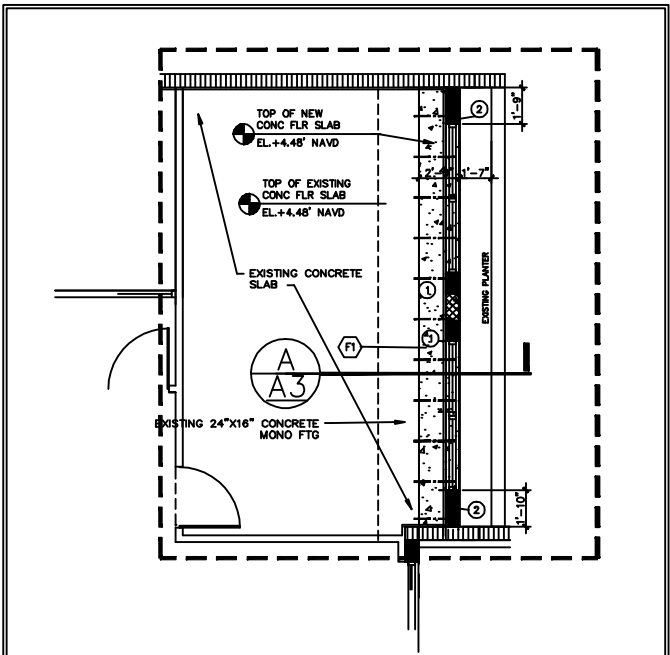

PARTIAL SLAB PLAN  
SCALE: 1/4"=1'-0"

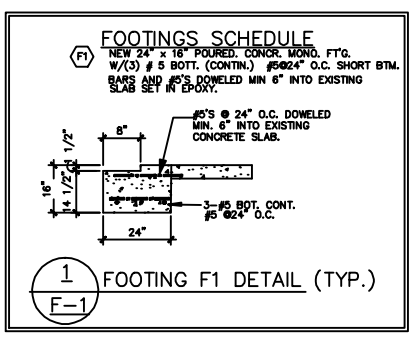

**COLUMN SCHEDULE**

COL.	SIZE	VERT. REINF.'g /CAP PL. & BOLTS	COL. TIES /BASE PL. & A.BOLTS	REMARKS
①	MIN. 8"x12" CONC FILLED	(4) #5	#3 @ 8" O.C.	
②	8"x21" CONC. STARTER COL.	(6) #5's	#3 @ 8" O.C. DOWEL #5 @ 12" O.C. VERT. INTO EXIST. SIDE WALL. SET IN EPOXY	

SEAL

---

REVISIONS

9-29-2020 permit set
----------------------

---

**GERALD BELGRAVE DESIGNS, LLC**  
 Architect - Planner - Interior Designer  
 4823 N.W. 66th AVE. LAUDERHILL, FLORIDA 33319  
 Phone (954) 298-2540  
 Arch. Reg. No. 15,085

---



---

**CONFERENCE ROOM EXPANSION AT**  
**2426 E. LAS OLAS BLVD.**  
**FORT LAUDERDALE, FLORIDA**

---

Sht. No. 20276	Date 8-19-2020	Drawn by JJB	Checked by GIB
-------------------	-------------------	-----------------	-------------------

ARCHITECTURE  
Drawing No. **A-3**